

**STREAM
TEMPERATURE
INVESTIGATIONS:
FIELD AND
ANALYTIC METHODS**

**INSTREAM FLOW
INFORMATION
PAPER: NO. 13**

**Biological Report
89(17) June 1989**

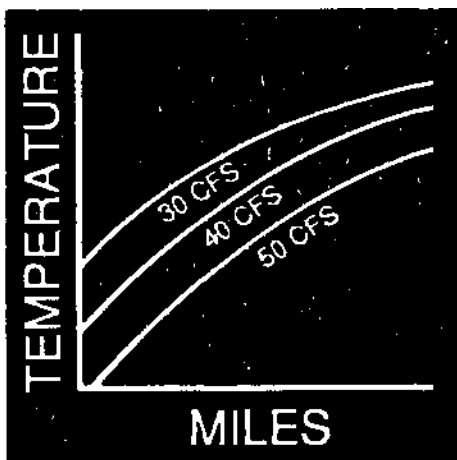

AQUATIC SYSTEMS BRANCH

Biological Report 89(17)
June 1989

STREAM TEMPERATURE INVESTIGATIONS:

FIELD AND ANALYTIC METHODS

Instream Flow Information Paper No. 13

by

John M. Bartholow
U.S. Fish and Wildlife Service
National Ecology Research Center
2627 Redwing Road
Fort Collins, CO 80526-2899

U.S. Department of the Interior
Fish and Wildlife Service
Research and Development
Washington, DC 20240

DISCLAIMER

The mention of trade names does not constitute endorsement or recommendation for use by the Federal Government.

Suggested citation:

Bartholow, J.M. 1989. Stream temperature investigations: field and analytic methods. Instream Flow Information Paper No. 13. U.S. Fish Wildl. Serv. Biol. Rep. 89 (17). 139 pp.

SUMMARY

This document provides guidance to the user of the U.S. Fish and Wildlife Service's Stream Network Temperature Model (SNTEMP). Planning a temperature study is discussed in terms of understanding the management objectives and ensuring that the questions will be accurately answered with the modeling approach being used.

A sensitivity analysis of SNTEMP is presented to illustrate which input variables are most important in predicting stream temperatures. This information helps prioritize data collection activities, highlights the need for quality control, focuses on which parameters can be estimated rather than measured, and offers a broader perspective on management options in terms of knowing where the biggest temperature response will be felt.

All of the major input variables for stream geometry, meteorology, and hydrology are discussed in detail. Each variable is defined, with guidance given on how to measure it, what kind of equipment to use, where to obtain it from another agency, and how to calculate it if the data are in a form other than that required by SNTEMP. Examples are presented for the various forms in which water temperature, discharge, and meteorological data are commonly found. Ranges of values for certain input variables that are difficult to measure or estimate are given. Particular attention is given to those variables not commonly understood by field biologists likely to be involved in a stream temperature study. Pertinent literature is cited for each variable, with emphasis on how other people have treated particular problems and on results they have found.

Model calibration, verification, and validation steps are defined and outlined, with measures of "goodness-of-fit" given for comparing simulated stream temperatures with observed values. The question of how good is good enough is explored, and attention is given to the kinds of simulation and data reduction errors that one should be alert for.

Some special cases dealing with ice and reservoir temperature are mentioned. Special attention is given to understanding micro-thermal habitats that act as important thermal refugia under low flow conditions; their causes, extent, and management implications are discussed.

Alternative public domain stream and reservoir temperature models are contrasted with SNTEMP. A distinction is made between steady-flow and dynamic-flow models and their respective capabilities. Regression models are offered as an alternative approach for some situations, with appropriate mathematical formulations suggested.

Appendices provide information on State and Federal agencies that are good data sources, vendors for field instrumentation, and small computer programs useful in data reduction.

CONTENTS

	<u>Page</u>
SUMMARY.....	iii
FIGURES.....	vi
TABLES.....	viii
ACKNOWLEDGMENTS.....	ix
INTRODUCTION.....	1
PLANNING A TEMPERATURE STUDY.....	5
UNDERSTANDING WATER TEMPERATURE THROUGH SENSITIVITY ANALYSIS.....	6
DATA GATHERING AND FIELD TECHNIQUES.....	12
Stream Geometry Components.....	12
Meteorological Components.....	34
Hydrology Components.....	51
Water Temperature Components.....	54
Special Cases.....	74
SIMULATION AND ANALYSIS TECHNIQUES.....	85
Alternative Predictive Techniques.....	85
Calibration/Validation.....	89
Other Stream Temperature Models.....	96
Special Cases.....	101
LITERATURE CITED.....	107
APPENDICES	
A. Data Sources.....	120
B. Equipment Vendors.....	121
C. Program Snippets.....	123
D. Alternative Data Formats from the Hydrodata Data Base.....	127
E. Selected Meteorological Data for July.....	132
INDEX.....	135

FIGURES

<u>Number</u>		<u>Page</u>
1	Approximate "temperature-limited" geographic range of rainbow trout under three scenarios.....	2
2	Various ways in which heat either enters or leaves a flowing stream	9
3	Sensitivity of the SNTTEMP model's predictions of mean daily water temperature to changes in various input parameters...	11
4	Sensitivity of the SNTTEMP model's predictions of maximum daily water temperature to changes in various input parameters...	11
5	Development of width versus flow relationships showing no effect of units of measurement on slope, but definite effect on intercept.....	15
6	Variation in travel time versus discharge for selected sites along a stream.....	17
7	Schematic of dye concentration versus time showing dispersion during time-of-travel study.....	19
8	Example of diel change in water temperature through time following clearcut.....	22
9	Effect of one timber management alternative on hourly water temperatures.....	25
10	Schematic showing the interception of solar radiation by topography and riparian vegetation.....	28
11	Conventions for determining the sign and degree of stream orientation as well as east and west bank designations.....	29
12	The "Bovee" home-made clinometer using a protractor, fishing weight, and soda straw.....	30
13	Riparian vegetation shade parameters.....	31
14	Influence of buffer strip width on shade density.....	33
15	Frequency distribution of temperature lapse rates at different altitudes.....	37
16	Field-installed meteorological station.....	38
17	Variation of amount of usable data from self-installed meteorological stations.....	40
18	Variation of air temperature above the Caney Fork River, TN....	42
19	Variation of relative humidity above the Caney Fork River, TN..	44
20	Total hemispheric radiation taken at Fort Collins, CO, during December 1988.....	45
21	Effect of shelter belt on various wind speed classes.....	47
22	Effect of various shelterbelt heights on wind speed.....	47
23	Annual variation of ground temperatures at Fort Collins, CO....	49
24	Departure from the mean ground temperature according to direction of slope and time of year.....	50

FIGURES (Concluded)

<u>Number</u>		<u>Page</u>
25	In situ and remotely configured thermographs.....	64
26	Priorities for installation and collection of water temperature monitoring locations for various stream network configurations.....	66
27	Cross-sectional temperatures showing degree of temperature variation for a given transect at a given flow.....	68
28	The different types of error that can arise in the measurement of temperature.....	72
29	Temperature versus distance versus time display.....	73
30	Common areas in which to expect temperature-created microhabitat..	80
31	Temperature profiles within a pool at various flows.....	82
32	Comparison of water temperatures in pools and upstream riffles	83
33	Full "split set" calibration/validation scheme.....	91
34	A spectrum of perspectives on possible causes of model error..	94
35	Duration plot for 30 years of daily air temperature from June 15 to August 15	104
36	Duration plot for 30 years of mean daily air temperature from June 15 to August 15.....	104
E-1	Normal daily average temperature for July.....	132
E-2	Mean relative humidity for July.....	133
E-3	Mean percentage of possible sun for July.....	133
E-4	Mean daily solar radiation for July.....	134
E-5	Mean wind speed for July.....	134

TABLES

<u>Number</u>		<u>Page</u>
1	Relative sensitivity of maximum and mean water temperatures to various parameters for a generalized stream.....	8
2	Range of input values used to determine relative sensitivity of SNTEMP.....	10
3	Percentage of incident solar radiation reaching various depths in water.....	20
4	Availability of useful data elements from two forms of Local Climatological Data Summaries.....	36
5	Percent reflectivity for various homogeneous ground cover conditions.....	51
6	Day length for various time frames and latitudes.....	52
7	Alternative forms in which you may find water temperature data in USGS publications or data bases.....	56
8	One form in which you may find water temperature data from a STORET data base.....	61
9	Example thermograph specifications.....	63
10	Average size, depth, and temperature depressions of the cool-water areas found by Bilby in a Washington stream.....	79
D-1	Textual output file from Hydrodata for mean daily water temperature.....	127
D-2	Textual output file from Climatedata for maximum daily air temperature.....	129
D-3	Part of a Lotus 1-2-3 worksheet created by Hydrodata Optical Disk Database.....	130
D-4	Textual output file from Hydrodata for streamflow.....	131

ACKNOWLEDGMENTS

Many people are due credit for this paper. Kay Lindgren and her staff spent many hours finding and obtaining documents for me. Terry Waddle reviewed an early draft and helped to firm up the contents. Other reviewers included Carl Armour, Dell Simmons, Dave Gilbert, Fred Theurer, and Ken Voos.

Special thanks are due to both John Homa and Wayne Lifton for extra-detailed review and comments. Kenny Dinan and Bill Slauson served to bring a real-world tone to the manuscript. Jenny Shoemaker and Mary Sanz did a fine job of making or obtaining the figures, and Trish Gillis made the manuscript presentable. Jim Zuboy provided a much-needed editorial review. Finally, thanks to Bob Milhous for pressuring me to do this job in the first place.

INTRODUCTION

Water temperature has always been considered one of the most important factors determining the geographic distribution of fish and other aquatic organisms. Analysis of water temperature regimes has lately taken on added importance, primarily for economic reasons. A recent newspaper article (Rocky Mountain News 1988) discusses the construction of a \$5.5 million reinforced-plastic curtain in northern California's Shasta Dam to transfer cool water from the reservoir into the Sacramento River to prevent salmon heat death. Without this curtain, the Bureau of Reclamation must release water without passing it through turbines at a cost of \$70,000 per day in lost power revenue.

Another study (Croley et al. 1981) has shown that the incremental cost of reducing thermal discharges to achieve a 3 °F (1.7 °C) reduction along the Missouri and Mississippi Rivers would be about \$211 million per year. This study measured power losses, but did not attempt to quantify fish and wildlife gains. In contrast, a paper by Theurer et al. (1985) developed a valuation of \$0.6 million per year for restoring a salmon population in the temperature degraded Tucannon River, a small Washington State river with a present worth of \$6.9 million. Clearly, these are large numbers, no matter which perspective one chooses.

Recent climatic changes have caused the earth's surface to be warmed by about 0.5 °C (0.9 °F) between 1861 and 1984, along with a decrease in the diurnal temperature range of about 1 °C (1.8 °F) (Zoltai 1988). A future perspective on water temperatures is even more interesting. The American Association for the Advancement of Science (1988) has concluded that scientists do not agree whether global warming is a reality or not. But it feels that it is at least prudent to look forward to what changes may be expected if the earth's atmosphere were to warm by 1.5-4.5 °C (3-8 °F) (Smagorinsky 1982). In addition to the flooding of coastal cities and other alarming large-scale problems, we might expect both a lesser amount of precipitation and higher air (and water) temperatures, especially in the western United States. If this were to occur, species now at the margins of their thermally defined geographic range may be expected to change rather dramatically (Figure 1).

The purposes of this report are many. First, it is intended to serve as a companion to another report in this series, Instream Flow Information Paper No. 16--Instream Water Temperature Model (Theurer et al. 1984), in which the theory and application of the Stream Network Temperature Model (and the SNTMP set of computer programs) are described. The information presented here will serve to broaden some of the concepts and methodologies outlined in that publication, especially in the area of field techniques and laboratory analytical methods. Second, information and advice on other data collection procedures will

CURRENT "TEMPERATURE-LIMITED" TROUT HABITAT

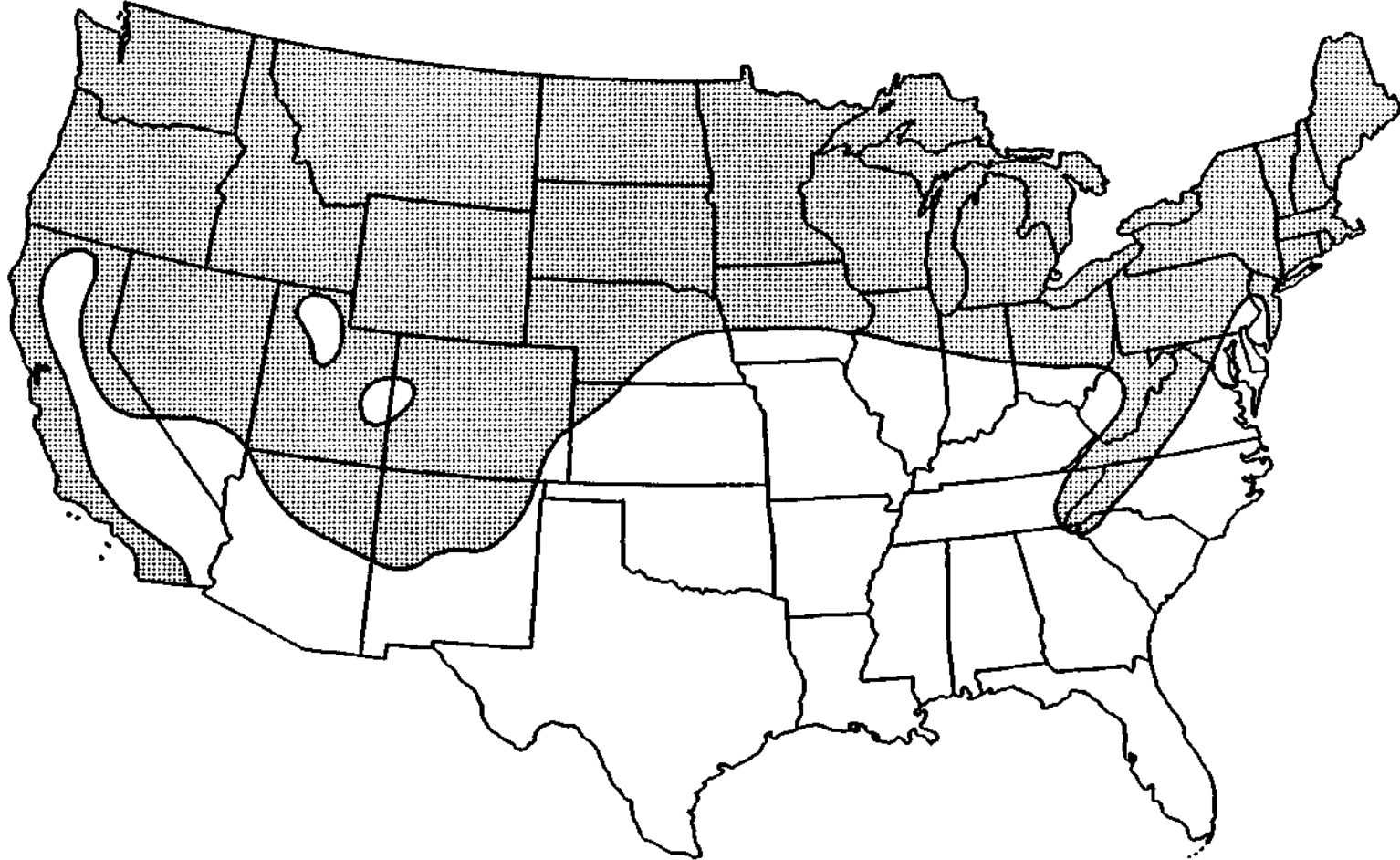

Figure 1a. Approximate "temperature-limited" geographic range of rainbow trout (*Oncorhynchus mykiss*, formerly *Salmo gairdneri*) under three scenarios: current conditions. Range defined by upper limit of 23.8 °C (75 °F) mean monthly surface water temperature. Figures derived from Hydrosience (1971).

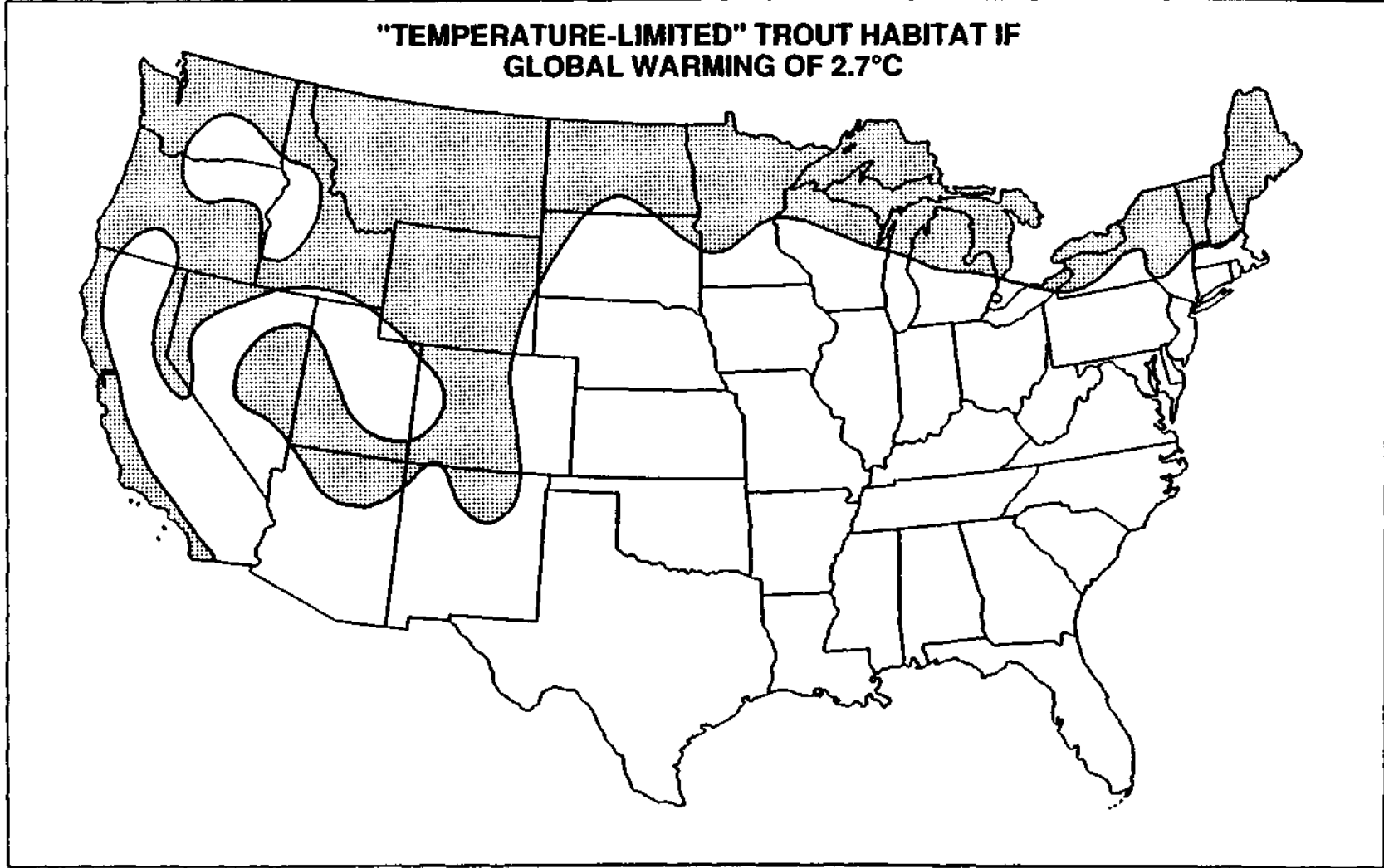

Figure 1b. Approximate "temperature-limited" geographic range of rainbow trout under three scenarios: assuming a 2.7 °C (5 °F) uniform global warming.

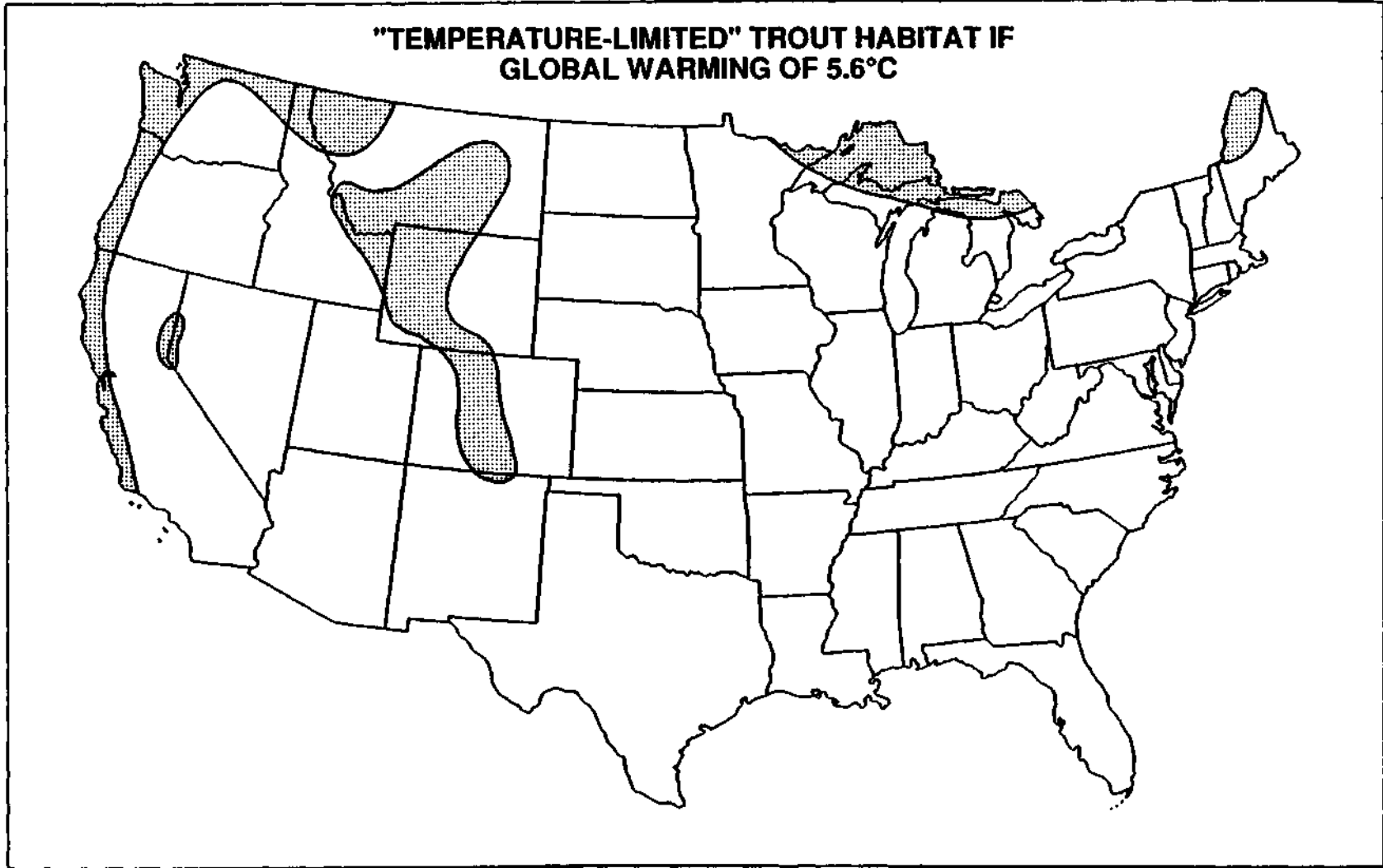

Figure 1c. Approximate "temperature-limited" geographic range of rainbow trout under three scenarios: assuming a 5.5 °C (10 °F) uniform global warming.

be presented. Numerous questions always arise as to where and how inputs to any temperature model can or should be obtained. For each model input, I explain what it is, what's known about it, and how to measure or estimate it. Third, ideas on what constitutes proper calibration/validation for temperature models are discussed, as there seems to be a lot of confusion over these and similar terms. I discuss what the terms mean, how to do things the "right" way, and when to do what. Finally, I give a brief review of alternative temperature models that may be used in place of the SNTMP set of models, and a brief review of reservoir and other water quality models that may be used in conjunction with stream temperature models.

One reviewer noted that this report will not be a "bestseller"; its audience is fairly specific, though the material is broad and diverse. It is directed towards those who have at least a general knowledge of Theurer's Stream Network Temperature Model and want to become more proficient in planning field activities or engaging in simulation/analysis techniques. Others may benefit from information contained here, but that is not the primary purpose.

PLANNING A TEMPERATURE STUDY

The Aquatic Branch is constantly reminded by users of our models, especially the more complicated SNTMP-type models, that we need to stress the need for careful study design. We assume that this means that there is difficulty in making sure that you (1) are going to be answering the right questions, (2) are using the right set of tools, and (3) can trust your answers.

The Aquatic Branch has written volumes on laying out a study plan (Bartholow and Waddle 1986) and scoping questions to ask (Bovee 1982). These publications have not seemed to dent the continued insistence that study design is critical. Therefore, we can only conclude that adequate study plans are not being assembled. Some have suggested that better prestudy involvement between all members of the "team" needs to be stressed. That is, planners, field data collectors, modelers, statisticians, decision makers, regulators, resource interests, developmental interests, and reviewers all need ACTIVE involvement to (after Henriksen, 1988):

- (1) identify the management problem (goals and objectives). Does this study deal with water rights or flow reservations? Is it to assess project impacts, evaluate mitigation, or approve permits? If it is an impact analysis problem, what is the appropriate baseline period with which to compare impacts? Are we at the feasibility or operational stage in the planning process? Is this a single project or a network of projects? Who are the players; who has the lead? How "important" is this project; is there a lot of resistance to a study of this type?
- (2) identify the appropriate species/life stages of concern. Is this a game, sport, or commercial fishery problem? Is it a sensitive or indicator species problem? Is it an endangered species problem?

Is it a "guild" of species or a planned introduction? Are we talking about a naturally sustaining population, supplemental stocking, or a put and take fishery? Do we have adequate life history information for periodicity, microhabitat preferences, and water quality?

- (3) identify the relevant variables to be measured/predicted. Is minimum, mean, maximum temperatures, or some combination the issue? Is a daily, weekly, or monthly averaging period appropriate? What is the spatial extent of your study area?
- (4) identify the appropriate criteria to employ. Are we talking about growth, mortality, trigger temperatures, temperature change rates, "minimum" flows, available fish habitat, population size, dollars, or commercial or recreational fishing effect? Do not proceed until criteria have been formulated and agreed to by all parties.
- (5) identify the quantitative measures for decision making (miles of suitable stream, temperature-conditioned microhabitat, hatching times, etc.). How concerned must we be about accuracy and/or precision? Do different players need different information to do their job?
- (6) identify and evaluate the feasible solution methods. Is adequate information already available to make the decisions at hand? If not, what techniques will best address the questions? Is there a favored method which has been used by local agencies? How much time, money, and manpower can (or should) be devoted to the problem and solution analysis? What is the time frame for decisions to be made? Can field studies be scheduled? What are realistic management options?

We hope that by getting all of the participants to reach a consensus on the above points, you will have come a long way toward resolving the impediments that sneak up on otherwise well planned and executed studies. The remainder of this document is devoted to helping you perform at least the temperature analysis effectively and efficiently.

UNDERSTANDING WATER TEMPERATURE THROUGH SENSITIVITY ANALYSIS

Prior to any extensive water temperature modeling or analysis activity, it is wise to understand the influences that various stream geometry, meteorological, and hydrological components have on determining water temperature. Such an understanding will better enable you to (1) prioritize data collection activities, (2) know the degree to which you should be concerned with quality control errors, (3) know which parameters can be safely estimated, and (4) broaden your perspective of potential management strategies. To further this understanding, we propose an initial consultation with a sensitivity analysis tool.

Sensitivity analysis of deterministic models is a valuable step in any model application. There are several specific uses for sensitivity analysis, some for the model builder and tester, and some for the model practitioner. Sensitivity analysis may be used to (1) serve as an aid in confirming that the model is consistent with theory, (2) show the effect that errors in each parameter have on the dependent variable (water temperature), (3) identify those parameters that are sensitive to the degree that they warrant very reliable measurement, and (4) show the relationship between the parameters subject to management control and the dependent variable (Reckhow and Chapra 1983). For our purposes, it will be valuable to learn where to concentrate data collection efforts, and how to display the effect that changes in flow, riparian shade, or channel characteristics have on stream temperature.

There are many ways of performing a sensitivity analysis on deterministic models. A common approach is a test in which a single parameter is systematically varied, while other parameters are held constant, and the response of the dependent variable is monitored. This allows us to say, for example, "A unit change in X produces a Z% change in stream temperature." A disadvantage of this technique is that it does not allow the practitioner to say what portion of the variance is attributable to a single parameter if the other parameters are also changing.

Table 1 illustrates the relative sensitivity of the key parameters used as input to most temperature models. This analysis was performed for the SNTMP model, many major components of which are illustrated in Figure 2, but the results would be expected to be similar across other deterministic stream temperature models. This table was generated by systematically varying the input parameters and noting the conditions associated with maximum changes in both mean and maximum water temperatures. This method gives a more robust picture of true sensitivities than varying a single parameter for only one set of other variables. It does not, however, explicitly consider the cross-correlation between parameters.

The parameters in Table 1 are ordered down the page from most to least sensitive for the generalized stream being simulated. Other streams will behave differently, but the general pattern should remain relatively stable. There are some obvious exceptions, however, such as the case of water temperatures immediately downstream of a reservoir, where the primary influence on temperature is the release temperature itself.

Parameters were varied for a generalized stream segment for an idealized July condition. The high and low values chosen to characterize this stream are shown in the Table 2. Items not shown in Table 2 were held constant; these values are: lateral flow, zero; upstream elevation, 100 feet; downstream elevation, zero feet; segment length, 10 miles; width's B value, .2; day length, 14.5 hours; and dam at inflow, true. Clearly, a headwater stream or a large river's parameters would be different.

Table 1. Relative sensitivity of maximum and mean water temperatures to various parameters for a generalized stream. Sensitivity as depicted here is dimensionless. Please see text for an explanation.

When these associated parameters are combined as shown:

Water temperature is:	To changes in these variables:	Stream flow	Inflow temp.	Width/depth	Thermal gradient	Air temp.	Relative humidity	Wind speed	Solar radiation	Percent shade
Very Sensitive	Air Temperature	low	low	high			high	high		
Moderately Sensitive	Percent Shade	low		high				low	high	
Moderately Sensitive	Relative Humidity	low	low	high		high		low		
Moderately Sensitive	Stream Flow		low	low		high	high			low
Moderately Sensitive	Inflow Temperature	high	high	low		low		low		high
Moderately Sensitive	Stream Width	low	low			high	high			low
Relatively Insensitive	Solar Radiation	low		high		low		low		low
Relatively Insensitive	Travel Time/Roughness		low					low	high	low
Relatively Insensitive	Wind Speed	high	low			high	high			high
Relatively Insensitive	Ground Temperature	low		high	high			low		
Insensitive	Percent Possible Sun	low		high		high		low		low
Insensitive	Thermal Gradient	low		high		high	high			

HEAT FLUX SOURCES

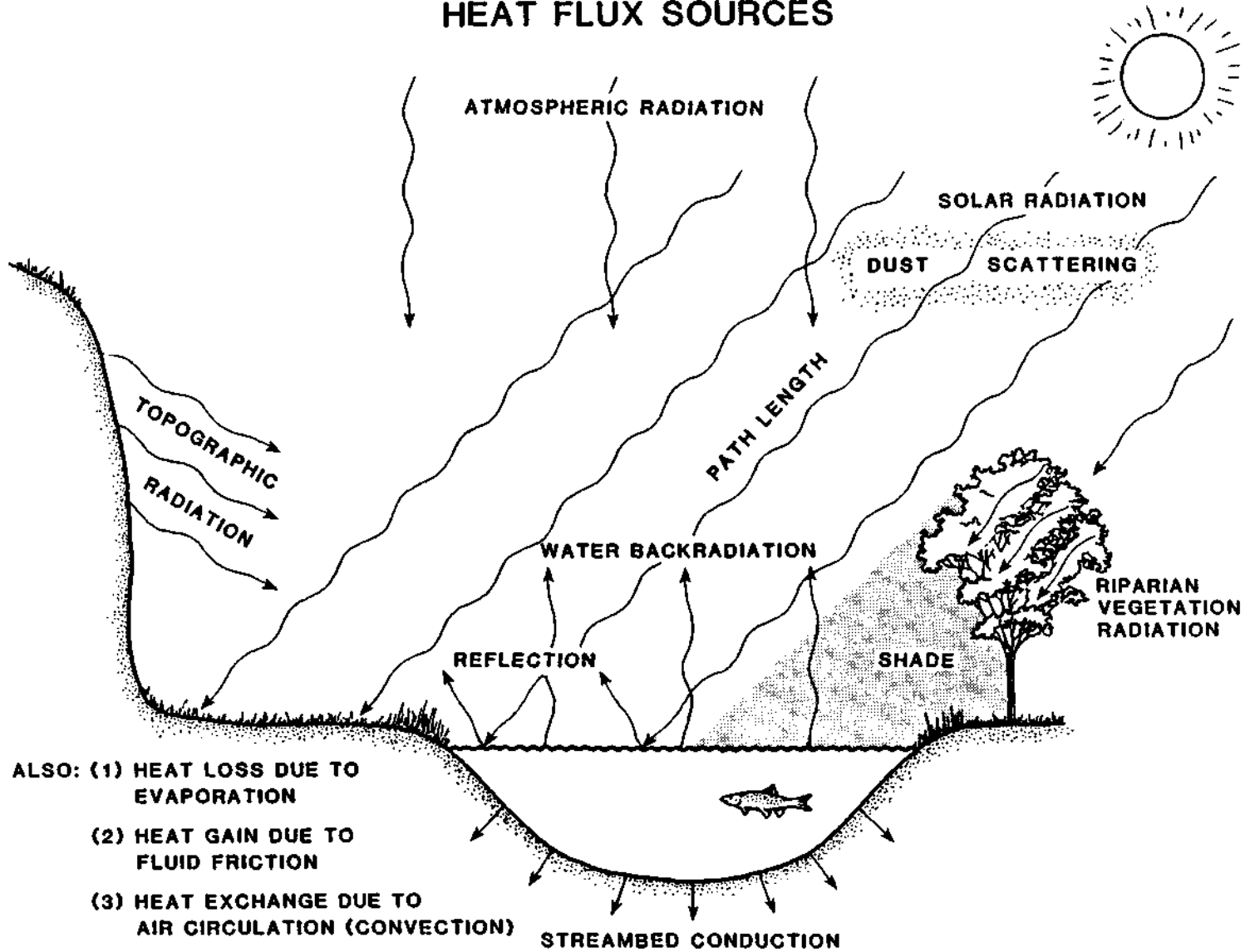

Figure 2. Various ways in which heat either enters or leaves a flowing stream. Adapted from Theurer et al. (1984).

Table 2. Range of input values used to determine relative sensitivity of SNTMP.

Parameter	Low value	High value	Units
Inflow	10.0	20.0	cfs
Inflow temperature	6.0	12.0	°C
Roughness	.035	.055	NA
Width's A	13.5	18.0	NA
Thermal gradient	1.5	1.8	j/m ² /sec/°C
Air temperature	65.0	85.0	°F
Relative humidity	40.0	70.0	percent
Wind speed	6.0	9.0	mph
Percent possible sun	60.0	80.0	percent
Solar radiation	495.0	630.0	Langleys
Segment shade	25.0	75.0	percent
Ground temperature	10.0	16.0	°C

In Table 1, water temperature is very sensitive to changes in air temperature when stream flow is low, inflow temperature is low, width-to-depth ratio is high, relative humidity is high, and wind speed is high. Water temperature may be sensitive to air temperature when these conditions are not present, but it will not be as sensitive.

Water temperature is insensitive to changes in thermal gradient all the time. However, changes in thermal gradient cause the most change in water temperature when stream flow is low, width-to-depth ratio is high, air temperature is high, and relative humidity is high. Note that the entry for travel time/roughness applies only to maximum water temperatures; it does not effect mean daily water temperatures in the SNTMP model.

Another way to look at the relative sensitivity of water temperature to changes in model variables is to plot the absolute change in predicted temperature produced by varying the parameters through the same combinations displayed above. The range of values so produced can be large. It is instructive to plot the data by quartiles, showing the minimum, maximum, and median values. Graphs for the mean and maximum water temperatures are shown in Figures 3 and 4. The values for mean and maximum are similar except for shade, solar radiation, and roughness.

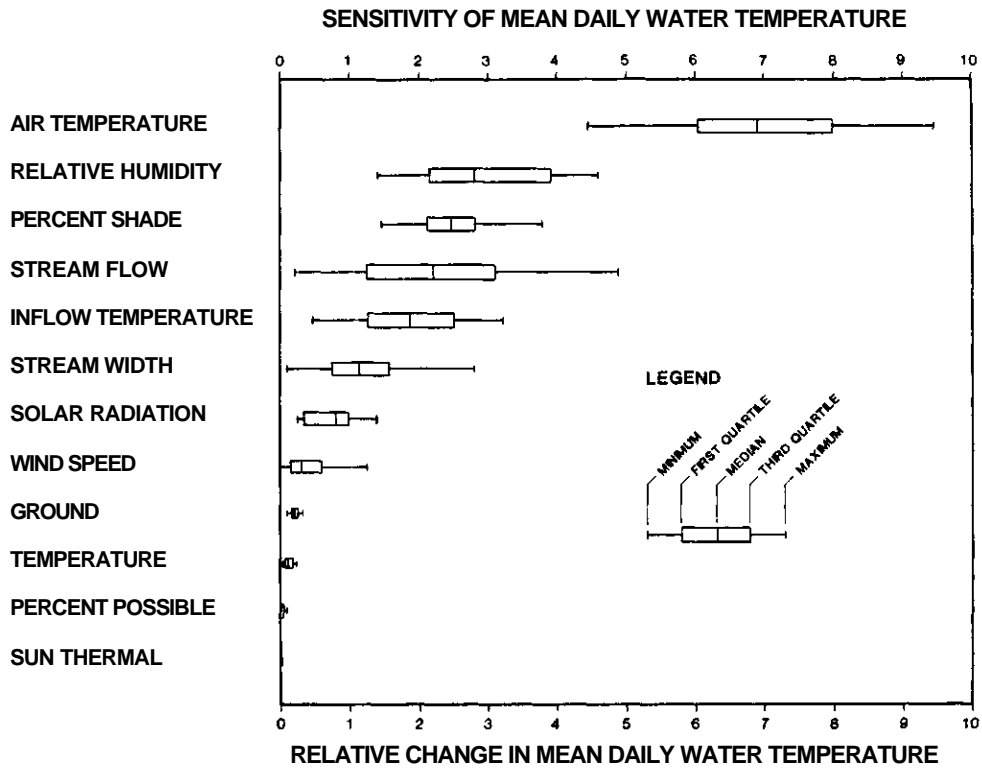

Figure 3. Sensitivity of the SNTemp model's predictions of mean daily water temperature to changes in various input parameters.

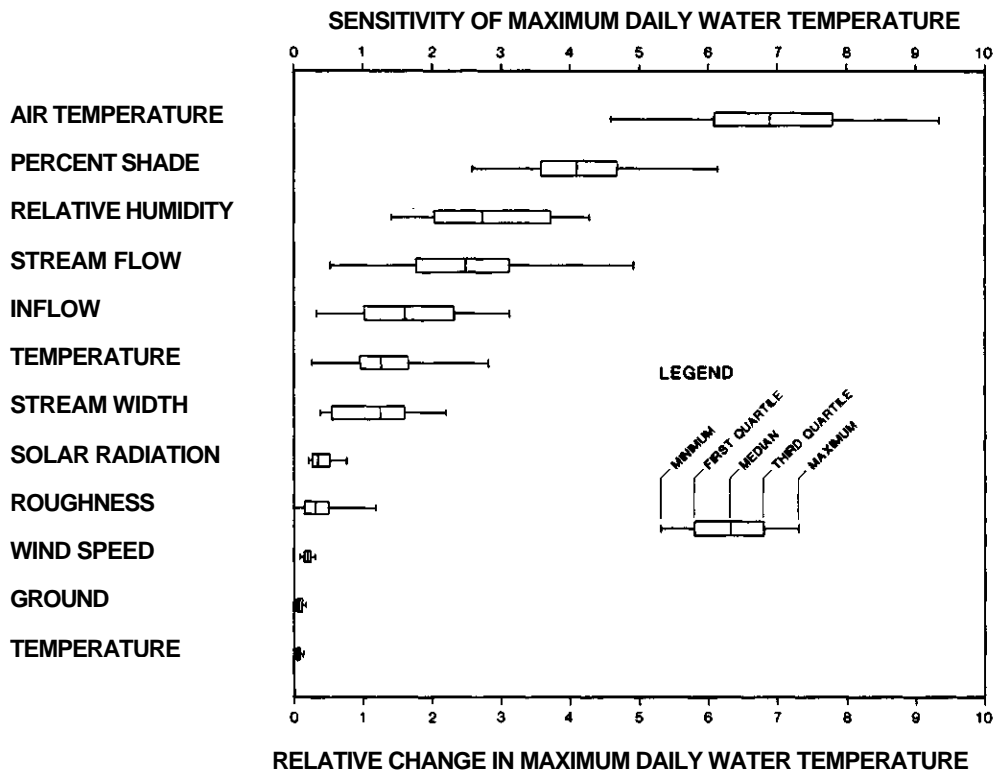

Figure 4. Sensitivity of the SNTemp model's predictions of maximum daily water temperature to changes in various input parameters.

Previous authors suggest that factors other than flow largely dictate water temperatures (Jowett and Mosley 1983; Laenen and Hansen 1985). Few authors have dealt with the sensitivity of water temperature models to a variety of parameters¹ (Moore 1967; Crittenden 1978). Crittenden's (1978) sensitivity analysis differs from my example and from other authors' in several respects. First, he varied only a single parameter at a time, and second, the model he used was developed solely for predicting equilibrium temperatures in small, unshaded, low gradient streams with little groundwater inflow. His results indicate that wind speed and the thermal properties of the substrate are the two most sensitive parameters. I find these conclusions suspect because these two parameters were varied over two orders of magnitude in the case of wind and one order of magnitude for thermal diffusivity. I do not believe these are reasonable variations for "real world" applications.

In summary, I strongly advise that a sensitivity analysis, even if crude, be performed prior to any field work or other data collection to determine which parameters deserve special attention. Do not take the examples given here as necessarily indicative of your situation.

DATA GATHERING AND FIELD TECHNIQUES

Armed with a general knowledge of which parameters are most likely controlling water temperature, we can proceed to the discussion of individual model parameters--what they mean and how to estimate them. Our discussion will be divided into three major groups: stream geometry, meteorology, and hydrology.

STREAM GEOMETRY COMPONENTS

Elevations, distances, and stream widths are fundamental stream geometry measurements. These get respectively more sensitive and also more difficult to calculate accurately.

Elevations

Elevations are important in temperature modeling for (1) calculating the slope resulting in heat from friction, (2) calculating the atmospheric pressure, an important element in heat convection, (3) calculating the depth of the atmosphere through which solar radiation passes, and (4) translating known air

¹ When reviewing their work, it is well to remember that there may not be an adequate distinction between air temperature and solar radiation. Accordingly, there may be confusion between proximate and ultimate causes in the sense that short wave solar radiation warms the air, which in turn emits long wave thermal radiation. In terms of heat flux, atmospheric radiation dominates most of the time, especially in the summer. Occasionally, the sensitivity discussion in the literature must be interpreted as sensitivity of maximum daily water temperatures, not mean daily.

temperatures and relative humidities to points of known elevation. Though any of these major processes may be of great importance, none are individually sensitive to small errors in elevation. Thus, elevations may be taken from readily available topographic maps even though contour intervals on some maps may be 40 feet and low relief terrain may not have easily discernable elevations. The most difficult task may be identifying where some station or node actually is on the map. For example, field work may have indicated significant changes in the distribution of riparian vegetation not apparent on the map. Be wary of trying to model very steep gradient, almost waterfall, situations; SNTEMP may dramatically overestimate heat flux due to friction if the stream width is too narrow.

Distances

Stream distances are important in calculation of heat transport. Distances basically translate to travel time and thus exposure time to all of the heat flux conditions. Aside from river mile indices that may be available, maps or aerial photos of known scale provide the easiest way to estimate distances. Distances can be a source of model bias if consistently over- or underestimated. Streams, being sinuous, can be tricky to measure reliably using a map and a map wheel, especially if the map has been protected with an acetate cover. It is best to measure the segments repeatedly, using a paper map, and take an average. In cases where you are aware that a schematic map does not convey the true sinuosity, it may be advisable to multiply the measurement by a "fudge factor" to account for the difference. It would be better to use aerial photos in this situation.

If a temperature analysis is being conducted in conjunction with a Physical Habitat Simulation Model (PHABSIM) analysis (Milhous et al. 1989), actual surveyed or paced stream segment distances may be available, especially if the detailed "habitat mapping" approach (Morhardt et al. 1983) is being used. It is always preferable to measure the distance the water is actually flowing. Also, distance may actually change as a function of flow. If large changes are anticipated, adjustments to model distances must be made in a fashion analogous to PHABSIM high-flow and low-flow models. That is, one set of data is used to describe the high flow conditions, one set the low flow.

Stream Width

Stream width can be a very sensitive parameter (recall Figures 3 and 4) in modeling water temperatures. All of the heat flux activities take place at either the air-water interface or the water-ground interface, both of which are as wide as the wetted stream width. At least one paper (Dymond 1984) attempts to develop a simple nonenergy balance model that predicts change in temperature based solely on changing the flow and hence width (depth) and time-of-travel.

The SNTEMP series of models employs a width as a function of flow relationship in the form of

$$W = a Q^b$$

where W = width (m)

Q = discharge (cms)

a and b = empirically derived coefficients

It is apparent that this formulation has the following properties. First, if b equals zero, the " a " term becomes the width. Second, the width will be zero if the flow is zero, not accounting for pools. Third, the relationship between width and flow is linear if plotted on a log-log scale.

The best procedure to develop this relationship is as follows. First, obtain several (three or more) sets of width and flow measurements at random points along each stream segment. This may be accomplished in the field or from output from the HABTAT (or related model such as AVDEPTH) portion of the PHABSIM models, which will report the total stream surface area (per 1,000 feet of stream) as a function of flow on the so-called HAQF output file. Care should be taken to make sure weighting factors are applied to represent the entire segment and that river bends are accounted for if necessary (program ADDBEND, Milhous et al., in press). Second, take the natural log of both width and discharge and perform a standard linear regression with discharge being the independent variable. The antilog of the intercept should be computed, not forced to zero, because it will be equal to the " a " term in the relationship. The " b " term will be the coefficient (slope) of the regression; the antilog of " b " should not be taken because it is a unitless term. Note that this analysis may be done in any units system you choose as long as they are consistent (Figure 5). Appendix C presents the skeleton of a Lotus 1-2-3 worksheet useful for doing this analysis.

Some authors (Currier and Hughes 1980) have argued that the width should only be measured for flowing water. Large pools with little or no flow, they state, do not influence the temperature of flowing water. I concur that areas of limited heat interchange may be omitted from width calculations. However, in areas where much of the flow goes through deep pools with little velocity, the width should not be adjusted. What is more important, I believe, is weighting the formulation of the coefficients toward the flow regime of importance. If you know, for instance, that you need the most accurate model for low flow conditions, only put low flow width measurements into your regression. Small braided streams will require more accurate field measurements (Currier and Hughes 1980).

If you cannot develop a width-flow relationship, set the b coefficient to zero and employ an average width.

Manning's n

This is a measure of the roughness of the streambed and channel, which causes flowing water to backup due to friction, and is a necessary component of the SNTTEMP model in predicting daily maximum water temperatures. At lower flows, the roughness tends to be due primarily to the stream bottom characteristics; as the flow increases, the whole channel shape, including river bends and constrictions, becomes dominant. Therefore, Manning's n is not constant with

POUDRE RIVER WIDTH-FLOW RELATIONSHIP
English Computation

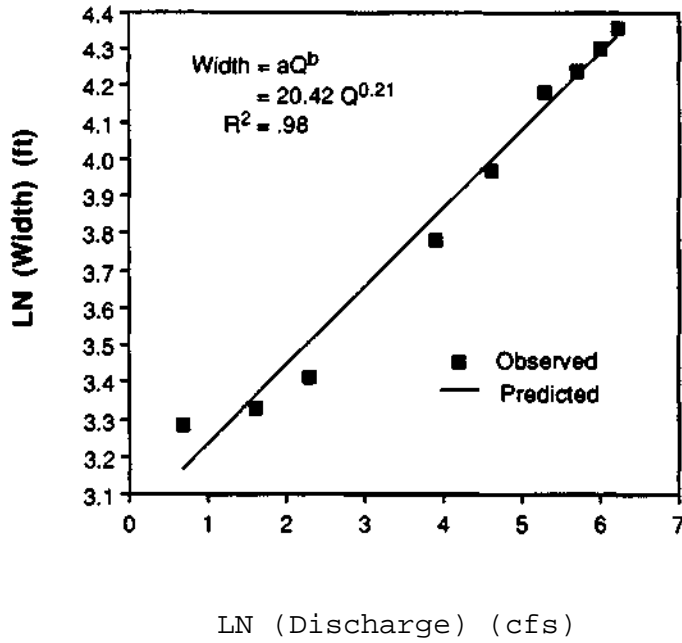

POUDRE RIVER WIDTH-FLOW RELATIONSHIP
Metric Computation

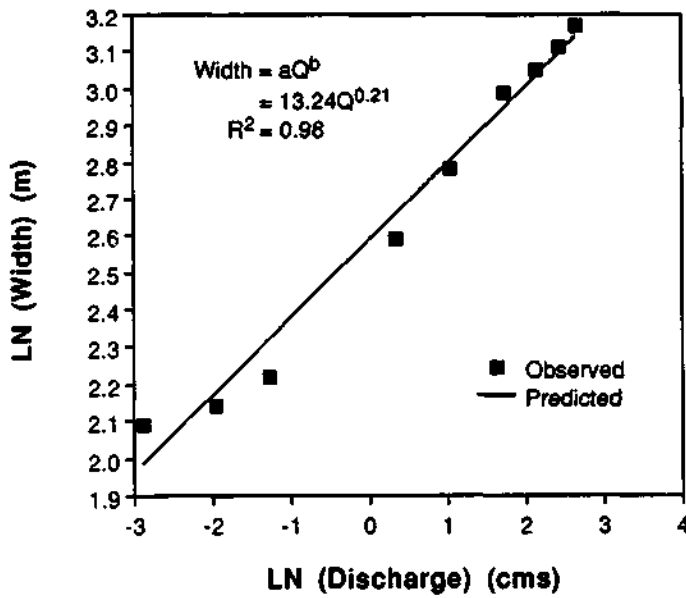

Figure 5. Development of width versus flow relationships showing no effect of units of measurement on slope, but definite effect on intercept.

changing flow, even though SNTEMP considers it a constant. Though there are guidelines an experienced hydrologist can use in determining roughness, the confidence interval surrounding such estimates is likely to be large (Platts 1981). Use of a step-backwater hydraulic simulation model, such as the Water Surface Profile (WSP) model (Milhous et al. 1988), may be a better method to estimate n. The use of a regression-type hydraulic model, such as IFG4 (Milhous et al. 1989), however, is not recommended; the "n values" used in this type of model are really "conveyance factors" and not true estimates of channel roughness.

Travel Time

Travel time is an alternative to Manning's n. Travel time is the inverse of velocity. If velocity is measured in units of length per time, then travel time is measured in units of time per length, such as seconds per kilometer in the SNTEMP model. Stream velocity, and therefore time of travel, vary with discharge. The relationship takes the form:

$$\text{Travel Time} = a Q^b$$

where a and b = empirically derived coefficients

$$Q = \text{discharge}$$

Note that the exponent b may itself vary as the flow-control varies with discharge. For example, the stream may change from a fundamental pool-riffle control to a channel control as the discharge increases. Consequently, three or more time-of-travel measurements may be necessary, depending on the range of flows of interest. If no control change takes place, a travel time vs. discharge plot may be constructed (Figure 6). If a control change is evident, such a plot would itself be curvilinear (Hubbard et al. 1981). Travel time may be either estimated or measured for steady or gradually varied flow conditions.

Often, travel time estimates are available from power/water companies. If travel time must be estimated from very limited data, the following empirical relationships, adapted from Boning (1974), may be used. These relationships were developed from 873 independent measurements throughout the United States. Note, however, the large standard errors involved.

Pool and Riffle Reaches (standard error = 40%)

$$TT = 1 / (0.38 Q^{0.40}) * S^{0.20}$$

Channel-Controlled Reaches (standard error = 26%)

$$TT = 1 / (2.69 Q^{0.26}) * S^{0.28}$$

where TT = travel time (s/ft)

Q = flow (cu.ft./s)

S = slope of streambed (ft/ft)

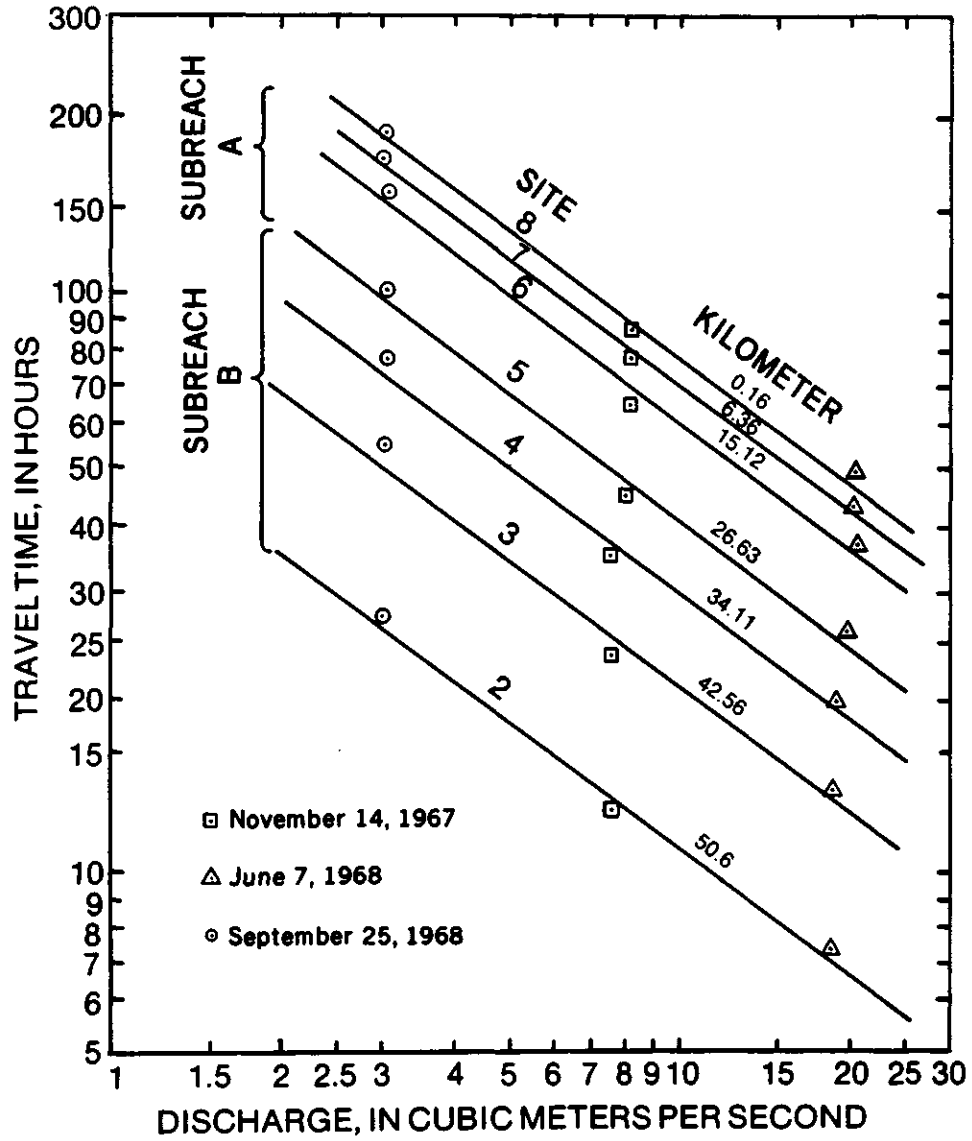

Figure 6. Variation in travel time versus discharge for selected sites along a stream. Reproduced from Hubbard et al. (1981).

The simplest, but most error prone, method of measuring travel time is the floating object method (Hamilton and Bergersen 1984). Its use is limited to straight and uniform stream segments, with minimum surface waves, on windless days. Floating object is a misnomer, for appropriate objects actually are immersed between one fourth of the depth and the bottom, and do not float on the surface. (In a pinch, a group of oranges may be used.) Establish three to five transects, far enough apart to actually measure an elapsed time. Intermediate transects provide double-checks on the estimates obtained. Several trials will be necessary, with the floats positioned at several locations across the initial transect, with the final answer being the mean time. Finally, multiply the mean velocity of a reasonably smooth stream by 0.8 to obtain the average, midcolumn velocity.

If a concurrent or previous PHABSIM study is available for the study stream, the detailed output from one of the hydraulic models may be examined and a mean travel time calculated from the total cross-section area divided by the discharge at each transect. According to one source (Hubbard et al. 1981), this method will tend to underestimate the travel time unless a weighted mean is computed by giving proportional weight to the length of stream represented by each transect (i.e., habitat mapping approach).

The next most accurate methods are probably routing studies or colored dye studies. In a routing study conducted below a controlled-release impoundment, an abrupt increase in flow followed by an abrupt decrease to the previous base flow is made. Staff gages, or stage recorders, located at downstream transects record the sequential passage of the release wave. Travel time is computed from the time of peak stage to peak stage between transects. Different base flows must be used to develop a travel time vs. flow function (Waddle 1987). Colored dye studies involve the instantaneous pouring of fluorescein or potassium permanganate into the stream far enough above the upstream transect to permit complete lateral dispersion. Dye behaves much the same as water molecules and moves on the average at the same rate as water. Travel time is computed by estimating the time when the "center of the color mass" passes the downstream stations. Considerable judgment is usually required to best gage the time at which the "best color" is reached. Experimentation is often necessary to achieve concentrations strong enough to be easily measured, but weak enough to not cause downstream complaints. See Hamilton and Bergersen (1984) for more details.

The Cadillac of methods is the true fluorometric dye study (Hubbard et al. 1981). The details and equipment are complicated and relatively expensive. A fluorometer is used to measure the light emitted from a fluorescent dye. The dye is selected for properties such as detectability, toxicity, solubility, and cost. The currently recommended dye is rhodamine WT, specifically formulated for water tracing. Concentration-time plots (Figure 7) may be constructed in a detailed dispersion study, or more simple peak-to-peak concentration times may be adequate in a less costly study. Rigorous standards must be met for injecting these dyes into water bodies that have water withdrawal points leading to human consumption. Significant effort is involved in successfully implementing a dye study of this sort. You should seek assistance from a hydrologist experienced in this type of study.

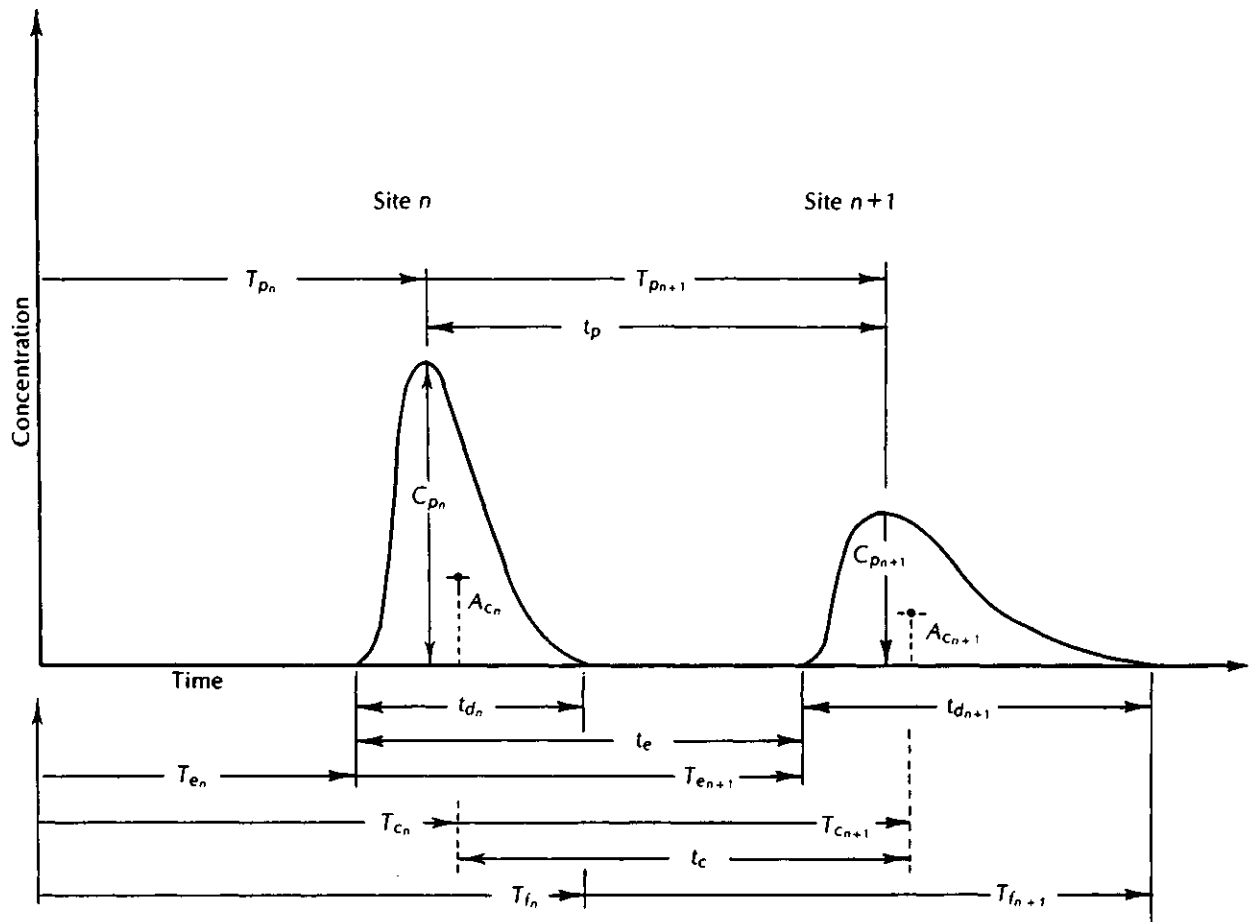

Figure 7. Schematic of dye concentration versus time showing dispersion during time-of-travel study. The X-axis also may be interpreted as proceeding downstream from left to right. Thus the magnitude of the concentration becomes attenuated through time (and space). Travel time is measured from peak concentration to peak concentration. Reproduced from Hubbard et al. (1981).

SNTEMP works with either a constant Manning's n or a constant travel time, both of which are truly dynamic with changes in discharge. If large variations are possible, high and low flow models should be constructed.

Thermal Gradient

The thermal gradient determines the rate of heat lost or gained from the streambed to the water. The thermal gradient may be thought of as the reciprocal of the more commonly known "r" value used in home insulation. The r value is

the resistance to heat loss; the thermal gradient is a measure of the conductance of heat. The larger the difference between the ground temperature and the water temperature, the greater the potential heat transfer. Though determined to be small relative to other parameters (Figures 3 and 4), some authors have determined the thermal gradient to be reasonably sensitive in predicting diurnal temperature variations in small, shallow streams (Jobson 1977). Comparing the results of models run with and without the consideration of a thermal gradient, Jobson determined temperature differences averaging about 0.25 °C (0.45 °F).

Comer and Grenney (1977) document a method for assessing the thermal gradient in shallow, sand- and gravel-bed streams. Measurement without disturbance is difficult, but possible. They concluded that for streams with significant interchange of water in the saturated zone below a river, the net heat flux from the "ground" into the stream at night may equal the outgoing flux at the air-water interface. They also suggest that solar radiation may indeed be directly absorbed by the streambed in clear, shallow streams.

Very clear streams with black or dark rock bottoms may display different diurnal temperature variation than would be explained by the SNTTEMP family of temperature models. Table 3 from Geiger (1965) shows the percentage of incident solar radiation reaching various depths in clear water. Note the significant decline in mid-wavelength radiation between 10 cm and 1 m. Thus, bottom conditions may not matter in streams deeper than 10 cm to 1 m.

Table 3. Percentage of incident solar radiation reaching various depths in water

	Depth					
	1mm	1cm	10cm	1m	10m	100m
0.2-0.6	100.0	100.0	99.7	96.8	72.6	5.9
0.6-0.9	99.8	98.2	84.8	35.8	2.6	0.0
0.9-3.0	65.3	34.7	2.0	0.0	0.0	0.0

In general, my sensitivity analysis demonstrated little influence exerted by the ground temperature. However, Jobson and Keefer (1979) showed that including the heat transfer at the streambed decreased the mean error in their dynamic temperature simulation, but increased the RMS error. They concluded that streambed conduction acts as a "damper" to temperature computation, which, overall, improved their modeling results.

Crittenden's (1978) sensitivity analysis showed that the diffusivity of the streambed was significant in an equilibrium temperature model developed for small, shallow, low gradient streams subject to intense solar radiation. The

effects of solar radiation are evident in the removal of night-forming anchor ice during the day (Ficke and Ficke 1977).

Comer and Grenney (1977) criticized many previous modeling efforts for not including heat transfer at the streambed. They concluded that diel variation of heat flux at the water-ground interface may approximately equal that at the air-water interface at night in clear, small mountain streams. Part of this heat balance was attributed to solar radiation reaching the streambed. In addition, they presented data on the magnitude of the diurnal variation of ground temperature at different depths and times of the day collected with a unique temperature probe. Brown (1969) also noted that conduction into the streambed was important in shallow streams having a bedrock bottom, but stated that gravel bottoms appeared to be insignificant as energy sinks. The color of the rocks have been cited as an influence here also (Currier and Hughes 1980). My conclusion from all of this is that hourly temperature simulations should pay attention to the thermal gradient and absorptive properties of the streambed, but daily simulations can safely ignore these elements. Daily simulations, however, should recognize that seasonal variation of ground temperatures may be a source of error if the models do not account for such change. See the section on ground temperature below.

Stream Shade

As shown in Table 1 and Figures 3 and 4, water temperature can be very sensitive to stream shading, especially for low flow, high width streams in midsummer. Shade, as considered here, comes in two forms, riparian vegetative shade and topographic shade from valley walls, cliffs, and even streambanks. Both forms result in the interception of the daily solar radiation from the water's surface. Though instream shade caused by fallen logs and brush often should be included, in practice it rarely is.

Shading affects stream temperatures in three primary ways. First, it screens the water's surface from the direct rays of the sun. Solar radiation may account for over 95% of the heat input during the midday period during midsummer (Brown 1970). Thus, it is one of the dominant factors affecting maximum daily water temperature, often more so than air temperature. Second, shade reduces the amount of the water's back radiation at night, tending to moderate the minimum stream temperatures. Third, shade produces its own long wave (thermal) radiation, which also tends to raise minimum temperatures at night. However, results of shade removal on minimum stream temperatures have not always been as expected, nor are they typically the same magnitude as changes in maximum temperature (Figure 8).

There are, of course, other direct and indirect effects of shade, or lack thereof, on the physical and chemical nature of streams. Shade removal allows increased light, which may result in increased algal production (Burton and Likens 1973), and also may influence migration or other movement activity, even due to bright moonlight (Lynch et al. 1984). Vegetative alteration also has the attendant problems of streambank stability and sedimentation. Coupled with peak flow events, streamside timber management practices may lead to long-term, cumulative temperature effects (Beschta and Taylor 1988). Shade-producing vegetation is closely related to the amount of instream cover produced by fallen

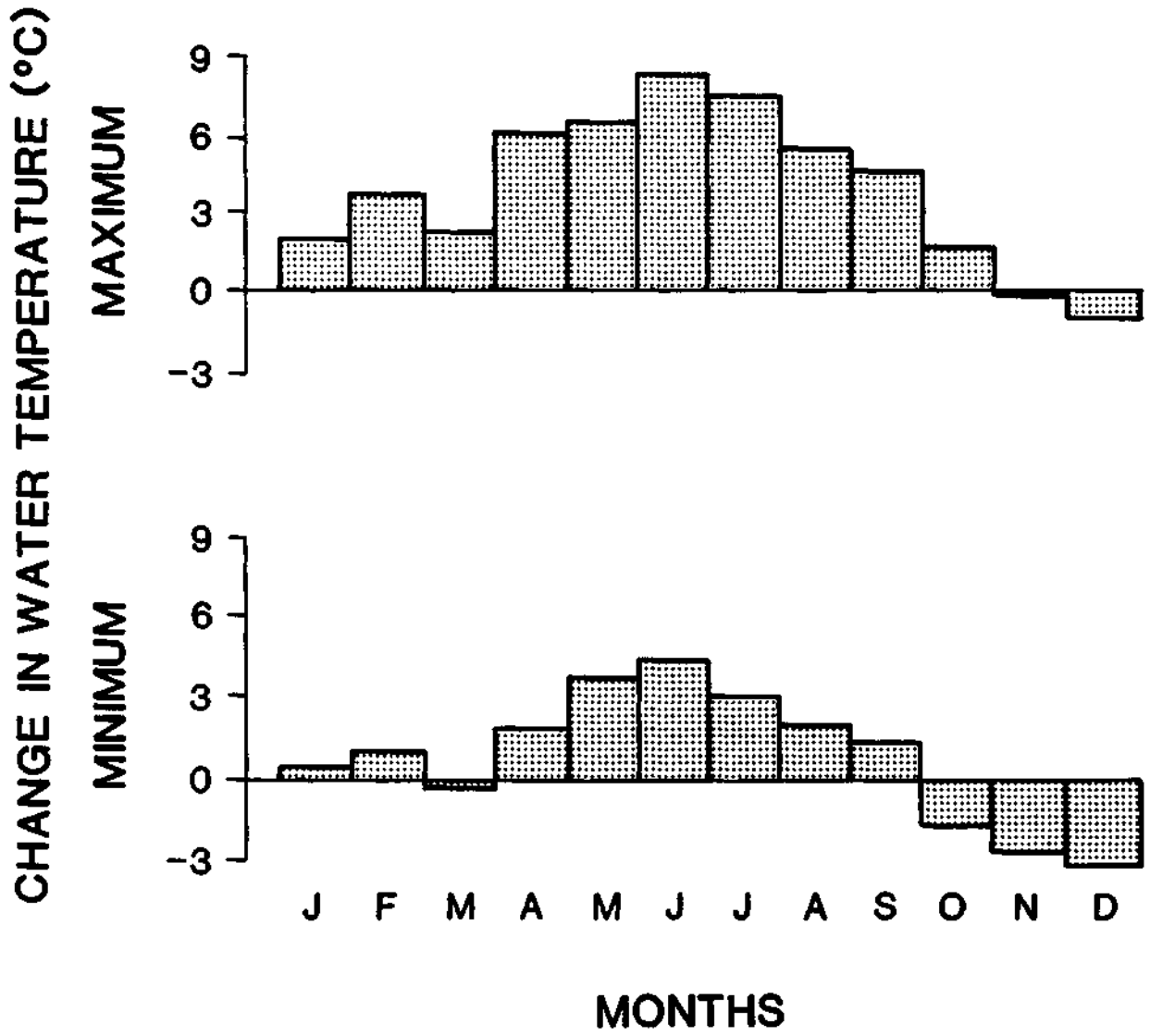

Figure 8. Example of diel change in water temperature through time following clearcutting. Adapted from Hewlett and Fortson (1982).

Much of the existing literature dealing with the effects of shade on water temperature comes from foresters' attempts to quantify the results of different clearcutting practices on stream temperature. The primary emphasis has been since the passage of the Federal Water Pollution Control Act as amended in Public

Law 92-500 (1972). In this legislation, stream temperature increases as a result of silvacultural practices have been designated as non-point source pollution. Each State was charged to develop "best management practices" to control the temperature increases (Patton 1973; Rishel et al. 1982).

The literature usually takes the form of a report detailing the temperature changes within study watersheds at different times of the year in different locations. A thorough reading of these reports typically shows much smaller changes in water temperature than their abstracts (which invariably describe the most extreme changes in minimum, average, or maximum stream temperature) would lead you to believe. This is not to say that acute lethal temperatures cannot be reached due to removal of riparian vegetation; it just means that extreme temperature changes are likely only during specific times of the year, only in watersheds whose geographic orientation lends itself to direct exposure to the sun, and usually if the vegetative removal causes other changes, such as an increase in groundwater temperature.

An unfortunate factor concerning much of the available literature dealing with shade, especially the earlier literature, is that the authors failed to clearly document the variables we now know are important, such as stream aspect, stream discharge, and stream width. In addition, it is deplorable that some authors did not define whether the temperature changes they measured were for minimum, average, or maximum stream temperature. An interesting exception is a paper by Barton and Taylor (1985) that looks at riparian land use in southern Ontario streams. In their study, the only environmental parameter that clearly distinguished trout and nontrout streams was weekly maximum temperature. This temperature, in turn, was largely predictable from the length and width of the upstream riparian buffer area.

What's known about shading effects. A brief literature review on shading effects follows. Meehan (1970) described the temperature changes resulting in small streams that ran alternately through clearcut or naturally open areas and sections that were shaded by vegetation in southeastern Alaska. The temperature differences on overcast days were small compared with sunny days. On clear days, he found temperature changes as high as +0.21 °C (0.38 °F) per 20 yards of stream in open areas, and as large as -0.18 °C (-0.32 °F) per 20 yards in shaded sections. The presentation of results is somewhat misleading, however, because the rate of change in either direction cannot continue indefinitely downstream. As water temperature approaches equilibrium, the rate of temperature change will decrease asymptotically.

Burton and Likens (1973) reported similar results on the Hubbard Brook Experimental Forest in New Hampshire. They showed rapid heating and cooling of small, low-discharge streams running through alternately cut and uncut forest strips on clear, sunny days in July. They documented rapid heating of 4-5 °C (7.2-9 °F) in the cut strips followed by similarly rapid cooling in the uncut strips. Cloudy day temperature changes averaged about 1.5 °C (2.7 °F). Though no discussion of methods is given, they reported that deciduous forest areas provided 50% to 60% shade during winter from the stems and branches alone. They also speculated that shade removal does not lead to as much nighttime cooling as expected, due to higher subsurface heat storage (in channel rocks and debris) in open water during the day. They state that the influx of cool groundwater

and contact with a cooler channel substrate may be responsible for the rapid cooling in the shaded areas. However, simple calculations suggested that these effects would be slight in total, and they could not explain all the phenomena they observed.

Brown (1970) developed relatively uncomplicated formulae that, used in combination with some associated tables and nomographs, are meant to assist in estimating the maximum temperature change (not the change in maximum temperature) due to clearcutting. He logically points out that since maximum temperatures will "undoubtedly" occur on cloudless days, "pure" solar radiation as predicted by simple models (such as SSSOLAR) eliminates the need for collecting detailed solar and cloud cover measurements. Further, Brown states that topographic shading can be ignored, since it is largely insignificant during the midsummer period. (Tests of Brown's hypothesis using the SSSHADE model indeed showed that even with east and west topographic altitudes of 25 degrees, midsummer shading from topography alone could only reach 11% at 40 degrees north latitude using a stream aspect of zero degrees. As the stream aspect deviated from zero degrees, the percent shade rapidly approached zero shade.)

Brown's formulae are simple, containing terms for only the surface area of the stream, rate of heat input, and stream discharge. He used this technique to predict temperature changes, following clearcutting, of 16 °C (28.8 °F) within 1 °C (1.8 °F). Even so, he is quick to point out limitations in his approach. Briefly, the method will not work well in streams with tributaries or with large daily changes in discharge, and it gives no allowance for only partial shade removal. Therefore, his technique typically results in overprediction of maximum temperature changes. This was not the case in results reported by Hewlett and Fortson (1982) in their experiments with Brown's model. They found an unacceptable underprediction of temperature changes, up to 20 °F (11.1 °C), using Brown's model, which led them to develop some simple regression techniques for predicting water temperature changes. Those regressions, however, produced high standard errors (5 °F, 2.8 °C) and low coefficients of determination.

Though neither detailed nor precise, Hewlett and Fortson's paper is interesting in several ways. They present evidence that leaving partial (35-to 50-foot) buffer strips along the riparian corridor may not always moderate the stream temperature effects resulting from clearcutting. They suggest that forest cover reductions in areas of gentle land relief may elevate the temperature of shallow groundwater moving into the stream. Therefore, shade should not be considered in isolation from other relevant inputs to whatever temperature model is chosen for a particular study. They show that although ground-water temperature measurements in deep wells remain within a few degrees of mean annual air temperature, the "effluent" ground-water temperature apparently varied from 43 °F (6.1 °C) in January to 70 °F (21.1 °C) in July. They suggest that results of other foresters' demonstrations of near-normal stream temperatures with retention of 25- to 50-foot buffers on each side of the stream (Swift and Messer 1971) have been due to steep terrain in which effluent groundwater is from a deeper origin.

Feller (1981) reported one example of how clearcutting of the shading vegetation may increase winter stream temperatures rather than decrease them, as would usually be expected. His report is intriguing in that it compares

winter warming effects of clearcutting alone with clearcutting/slashburning, which decreased winter water temperatures. No conclusions were reached as to the reasons for the differences. Rishel et al. (1982) found the more typical decreases of minimum, average, and maximum stream temperatures in winter after both commercial clearcut and clearcut-herbicide treatments. Although average diurnal changes in temperatures were large for part of the year (Figure 9), the temperature changes generally were not statistically significant in December, January, or February. Lynch et al. (1984) and Swift et al. (1971) reported similar results.

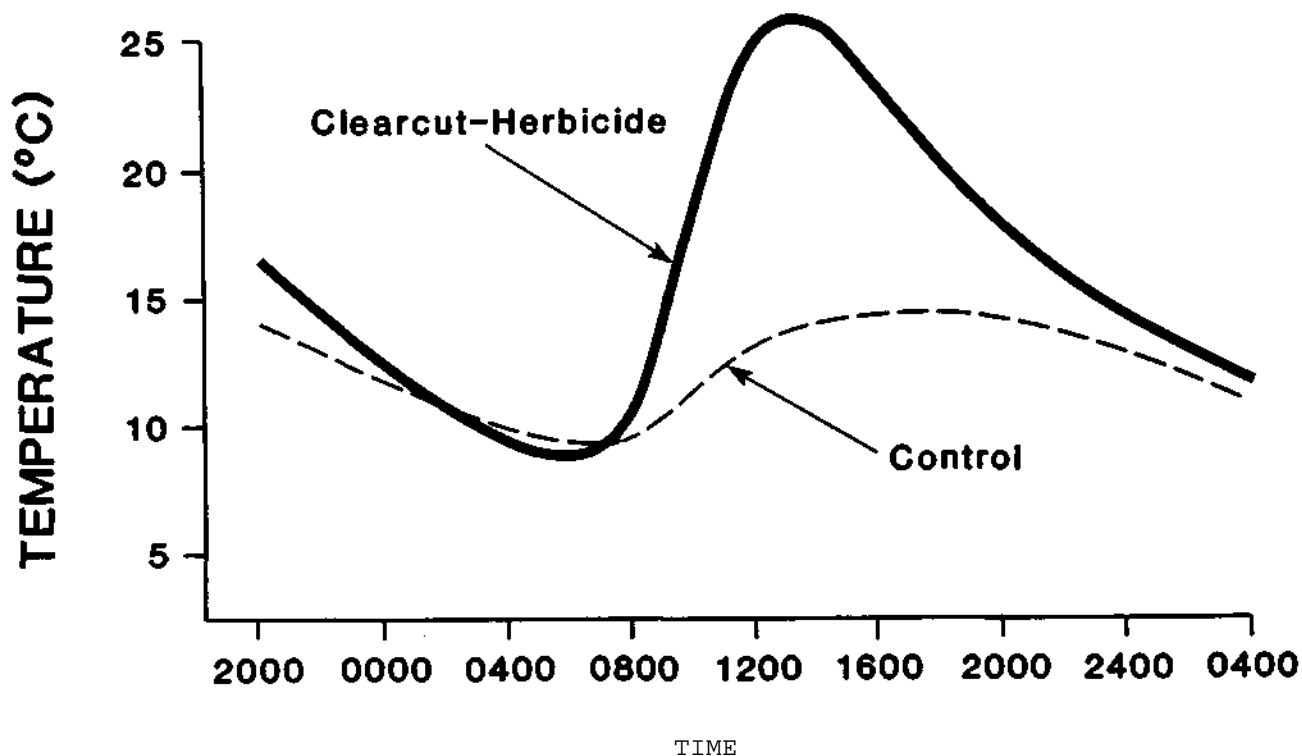

Figure 9. Effect of one timber management alternative on hourly water temperatures. Adapted from Rishel et al. (1982).

Finally, in a broad analysis of Oregon streams, Moore (1967) concluded that stream orientation alone was sufficient to produce definite categories of temperature profiles. He found that east-west oriented streams could have temperatures 2 to 4.5 °C (4-8 °F) warmer than north-south oriented streams. Approaches similar to this are being used to "fine-tune" timber harvest restrictions in varied topography.

In a different vein, some investigators have looked at the "direct" relationship between shade and the biological community, skipping the intermediate temperature step altogether. Platts et al. (1983, p. 58) mentioned

taking opposite horizon angles with a clinometer, subtracting the sum from 180 degrees to obtain what they called the "sun arc degrees." They found that this measurement correlated well with fish standing crop in higher elevation streams, providing good year-to-year accuracy and narrow confidence intervals.

How to measure shade in the field. Shade measurements can be costly to make. I recommend that detailed shade measurements be made in only two cases. First, careful attention must be given to shade measurements in any stream project that includes alteration of the shade as an explicit or implicit management option. Second, if experimentation with a trial version of the temperature model suggests that shade is a sensitive parameter, then due attention must be given to it. Otherwise, relatively simple, quick-look "windshield surveys" should provide satisfactory shade measurements.

Quigley (1981) outlined the computational procedures for estimating the contribution of riparian vegetation to stream surface shade. He considered the wetted stream width, distance from wetted edge to the vegetation, crown measurements and density, stream aspect, latitude, date, and time of day. Quigley also illustrated how to perform a sensitivity analysis with shade variables, but discusses why it is impossible to truly generalize the results to any stream condition.

Quigley (1981) recommends that the crown measurements for deciduous trees be the diameter, while using the radius for conifers with a triangular shape to account for the tapering shadow. Other practitioners of this technique (Voos 1986) also recommend this approach. However, I have observed that shadows cast by conifers rarely assume this tapered shape on any streams except those oriented nearly north-south. You must judge the best method for specific situations.

Quigley's techniques were subsequently modified and enhanced by Theurer et al. (1984) to include topographic (and streambank) shade, integrate over the course of a multiday time period, and add shade quality as an additional variable. Quigley points out that the shading is a function of stream width, which in turn is a function of discharge. This is a feature not dynamically considered in the SNTMP or SSSHADE shade models, but has been considered in dealing with watershed alterations in Washington State by Theurer et al. (1985) in a general application of the network temperature models. That is, the shade algorithms work only with a constant stream width. You should characterize the width as that most indicative of the important conditions. If low flow-high temperature conditions are to be simulated, make the average width for the shade calculations be representative of those low flow conditions.

The algorithms developed by Theurer compute the position of the sun with respect to the location of the stream segment on the earth's surface. Day length is first computed for the level-plain case, i.e., as if there were no local topographic influence. Next the local topography is factored in by recomputing the sunrise and sunset times based local topographic angles; this local topography results in a percentage decrease in the level plain daylight hours, technically termed "hour angles." From this local sunrise/sunset, the program then computes the percentage of light that is filtered by the vegetation. This filtering is the result of the size, position, and density of the shadow-casting vegetation on both sides of the stream. The topographic shade and vegetative

shade are merely added to get the total shade. However, one should think of topographic shade as always being dominant in the sense that topography always intercepts radiation first, then the vegetation intercepts what is left (Figure 10).

To use the preferred method of calculating shade, one must estimate or measure latitude, stream azimuth, topographic altitudes, and riparian shade parameters. Latitude, of course, may be taken off of a standard USGS topographic map. The other parameters require more explanation and will be detailed below. In addition, keep in mind that we are talking about "averages" for a stream segment in measuring what often is a very irregular or patchy variable. Here are some tips on how to make these measurements.

Azimuth refers to the general orientation of the stream reach with respect to due south, and controls which sides are called east and west, by convention. Measure towards the west for positive degrees and towards the east for negative, regardless of the direction of flow. Refer to the following figures for guidance: for example, if the stream were flowing in a generally northwest-southeast direction as in parts e or f of Figure 4, the azimuth would be approximately -45 degrees.

Once the azimuth is determined, usually from a topographic map, the east and west sides are fixed by convention (Figure 11). When the angle is small, east and west are obvious. As the angle approaches plus or minus 90 degrees, it is less clear. Imagine an azimuth of plus 90 degrees; the actual north shore is termed west. Similarly, if the azimuth is -90 degrees, the north shore is termed east as far as this program is concerned. This convention is easy to understand if you visualize varying the azimuth from zero degrees and note that west and east always stay on the same side of the stream.

The remaining parameters may all be estimated, with correspondingly more accuracy for direct field measurements. Random samples would undoubtedly provide the most accurate and robust figures. Reifsnyder and Lull (1965) recommend 20 to 40 samples in bright sun, fewer if cloudy. See Platts et al. (1987) for information about designing a random sampling procedure.

The topographic altitude is a measure of the average line-of-sight angle to the horizon from approximately the middle of the stream, measured in degrees. Both east and west sides will require altitude measurements. The altitude may be measured precisely with a clinometer or fairly accurately with a protractor (Figure 12). If a clinometer is used, you will find that one with a degree scale is preferable. Topographic maps may be used with caution, but in mountainous terrain, it will be difficult to estimate topographic altitudes from a topo map, as it becomes virtually impossible to tell where the horizon, as seen from the stream, actually is. In flatter country, the stream bank itself may be the overriding topographic horizon.

The vegetation height (V_h in Figure 13) is the average height for the existing or proposed shade-producing strata of vegetation along the stream from the water's surface. Note that this should not be the height of the vegetation

IDEALIZED REPRESENTATION OF HOUR ANGLES

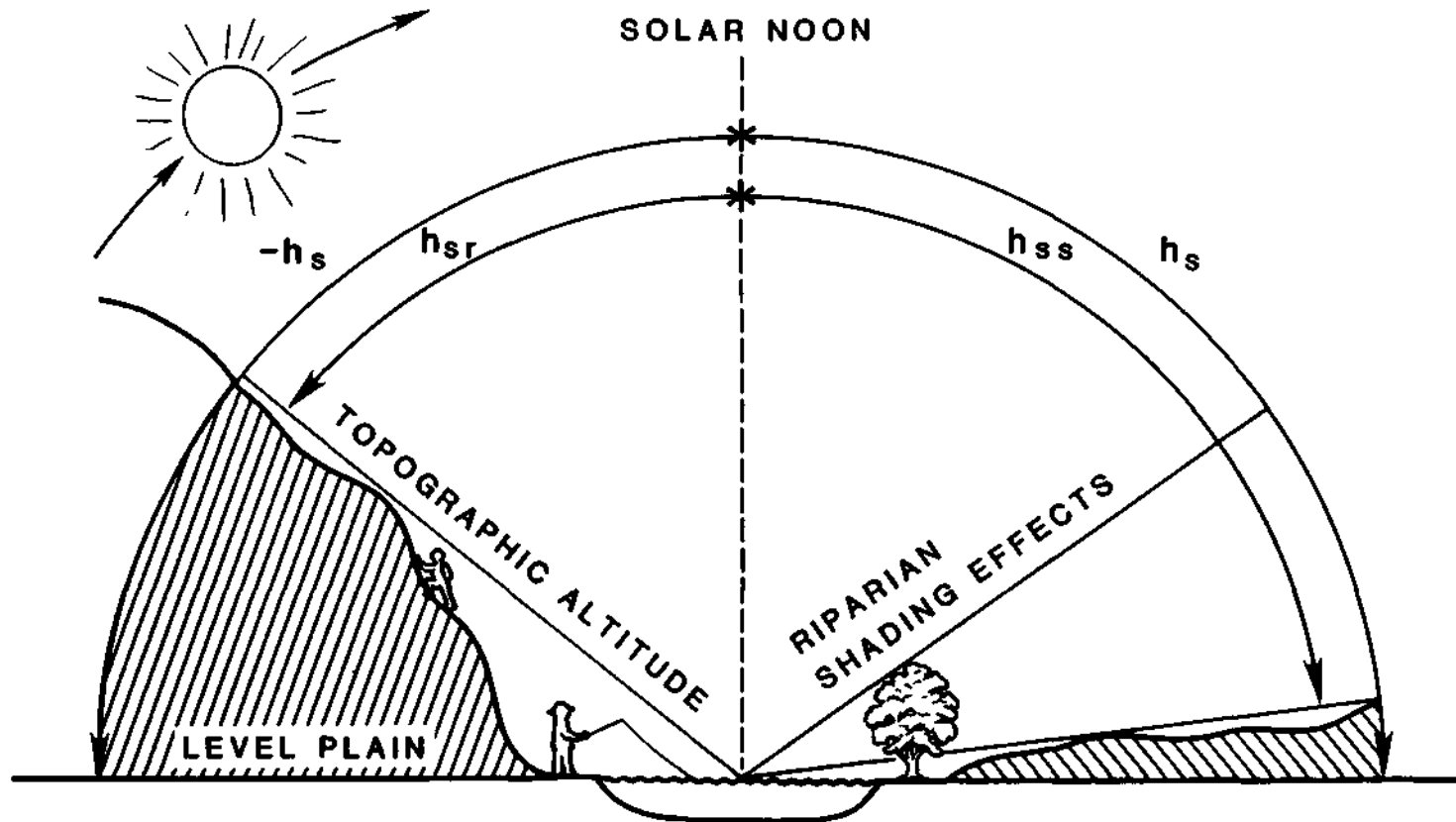

h_s - LEVEL PLAIN SUNSET HOUR ANGLE

h_{sr} - LOCAL SUNRISE HOUR ANGLE

h_{ss} - LOCAL SUNSET HOUR ANGLE

1 HOUR - 15° OF HOUR ANGLE

Figure 10. Schematic showing the interception of solar radiation by topography and riparian vegetation. Adapted from Theurer et al. (1984).

CONVENTIONS FOR DETERMINING
STREAM AZIMUTH AND EAST/WEST BANK

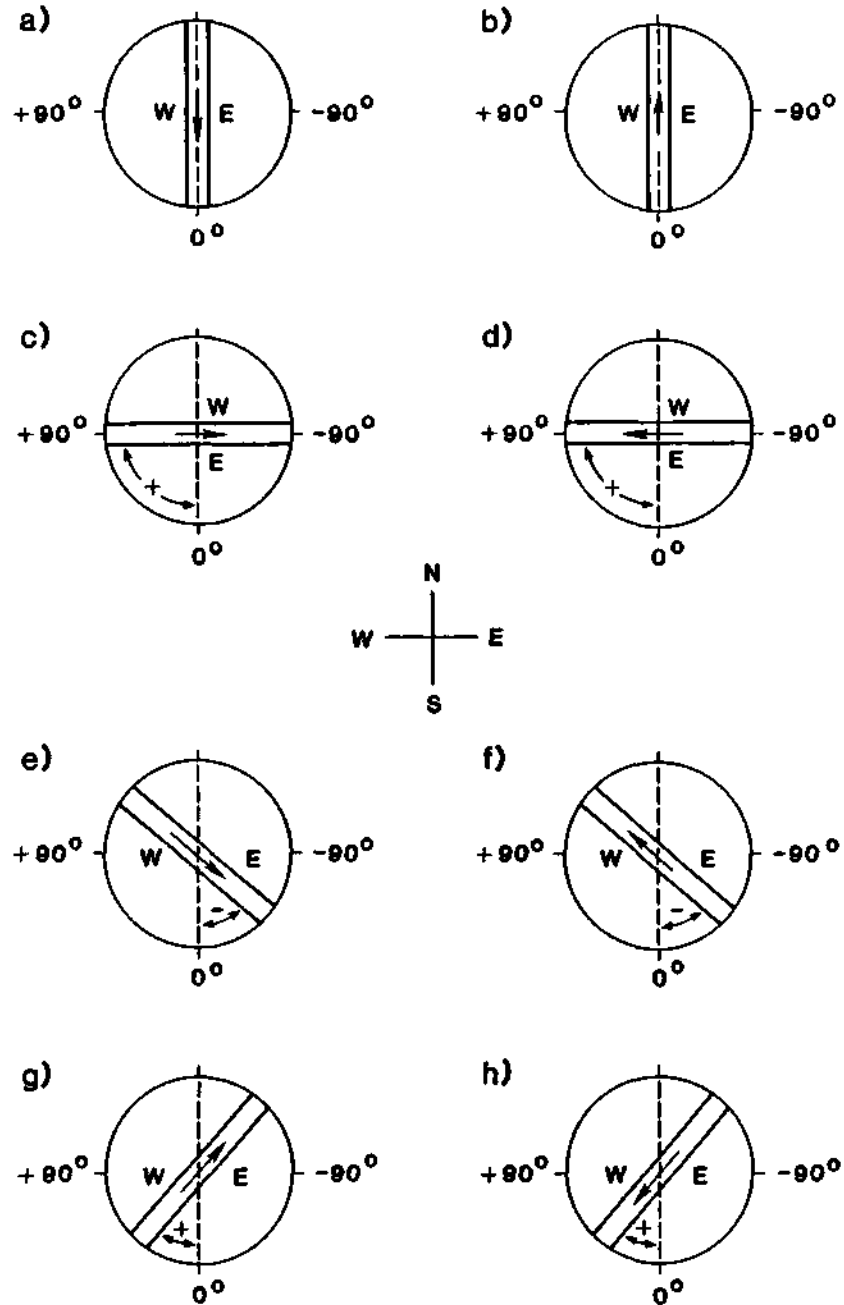

Figure 11. Conventions for determining the sign and degree of stream orientation (azimuth) as well as east and west bank designations. Note that the direction of stream flow (single-headed arrow) is unimportant for these determinations.

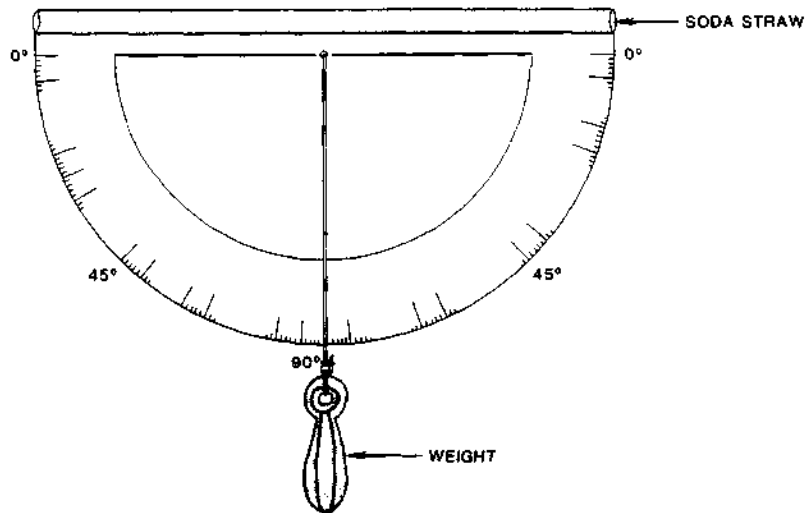

Figure 12. The "Bovee" home-made clinometer using a protractor, fishing weight, and soda straw.

itself, i.e., there is no need to correct for the height of the stream bank. Also note that all shading is important; understory trees, brush, and shrubs may be more significant than commercial grade timber in many cases (Currier and Hughes 1980). Both east and west sides may be measured independently. The height may be calculated by the formula $H = D * \text{TAN}(A)$, where H is the height, D the distance from the observer (in the water) to the vegetation, and A the angle from the water surface to the tops of the vegetation. The simple protractor or a clinometer may be used to estimate the angle. Some clinometers also have a built-in rangefinder so that the distance to the vegetation may be measured simultaneously with the topographic altitudes. You should also correct for the height of the observer. Most clinometers come with instructions for making these calculations.

The vegetation crown (V_c) is the average maximum crown diameter for the existing or proposed shade-producing strata of vegetation along the stream. Values for both east and west side may be independently measured. Direct measurement or estimation from aerial photos may be used. Even if vegetation is continuous, the diameter is important in the model's calculation of overhang.

The vegetation offset (V_o) is the average offset of the trunks of the existing or proposed shade-producing strata of vegetation from the water's edge. You may need to vary this if you vary the stream width. Values for both east and west side may be independently measured.

The vegetation density (V_d) is the average screening factor (0 to 100%) of the existing or proposed shade-producing strata of vegetation along the stream. It is actually composed of two parts: the continuity of the vegetative coverage along the stream (quantity), and the percent of light filtered by the vegetation's leaves and trunks (quality). This percent of light may need to be adjusted for the time of year if you are dealing with deciduous vegetation. The Stand-Alone Shade Model (Theurer 1984) provides for such variation with time of year.

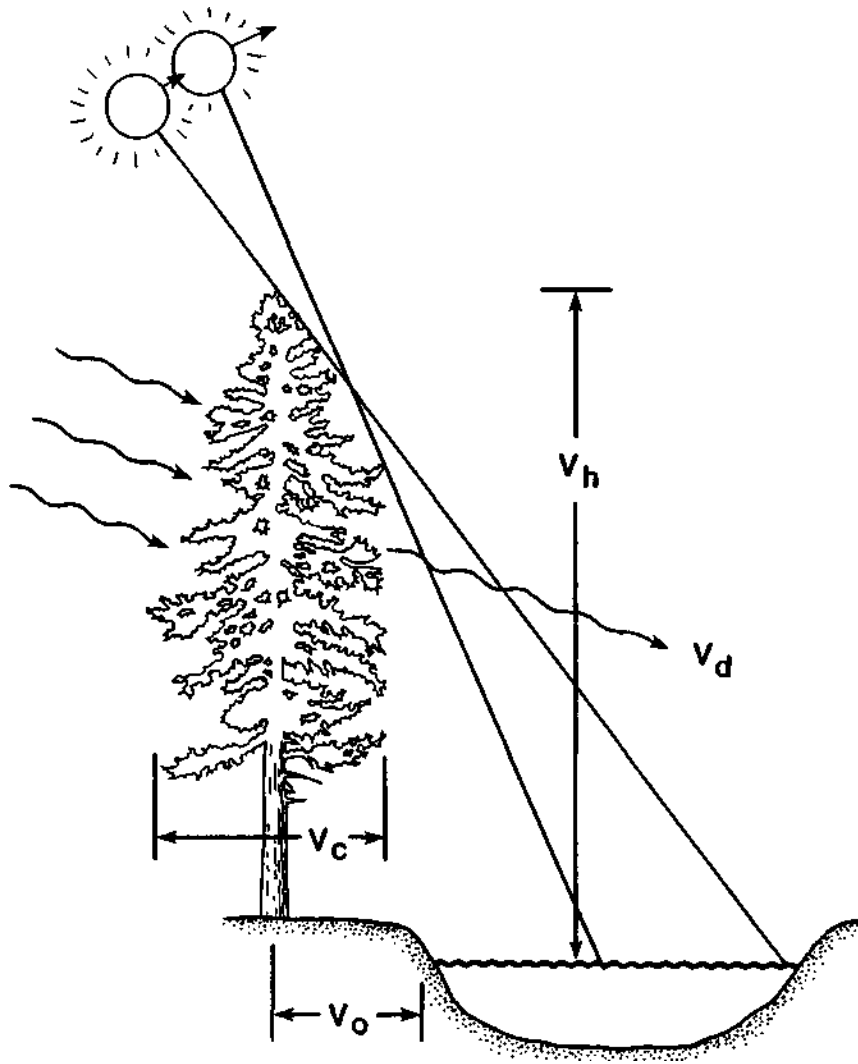

V_h = average vegetation height

V_o = average vegetation offset

V_c = average maximum diameter

V_d = ratio of shortwave radiation
eliminated to incoming over
entire reach shaded area

RIPARIAN VEGETATION SHADE PARAMETERS

Figure 13. Riparian vegetation shade parameters. Modified from Theurer et al. (1984)

For example, if there is vegetation along 25% of the stream and the average density of that coverage is 50%, the total vegetative density is .25 times .50, which equals .125, or 12.5%. The decimal value should always be between 0 and 1. Values for both east and west sides may be independently measured. Though the continuity factor may be adequately estimated by skilled photo-interpreters, the shade quality cannot. Both may be estimated by measurements taken in a sampling along the stream.

To give examples of shade quality, an open pine stand provides about 65% shade; a closed pine stand provides about 90% shade; a tight spruce/fir stand provides about 85% shade; areas of extensive, dense emergent vegetation should be considered 90% efficient for the surface area covered. Some other estimates are available from ReifSnyder and Lull (1965).

One common method of measuring shade density is to use a concave spherical densitometer (Platts et al. 1987). This method has been shown to be accurate in the measurement of forest overstory density (Lemmon 1956), but is not recommended for our purposes for two reasons. First, it is extremely difficult to measure the quality of the shade because one can only classify shaded or unshaded, not the degree of shading. Second, this method does not account for filtering along the path of the sun.

To correct this "along the path" problem, Brazier and Brown (1973) pioneered the use of what they called Angular Canopy Density when measuring the width of clearcut buffer strips. Basically, they showed that what was important was not the absolute width of the buffer strip, but the actual shade resulting from that buffer strip. They advocated consideration of the stream's orientation with respect to the north-south axis, and measuring the canopy density along the path of the incoming solar radiation, rather than vertically through the canopy. They used this technique to visually survey shading. Their reported values range from 18% to 80% in different width buffers, the vegetation being red alder and conifers. Though part of their logic is not clear to me when it comes to the relationship between measured angular canopy density and actual heat blocked, the results showing the relationship between buffer strip width and shading density (Figure 14) illustrate a useful concept that has been used to select "leave trees" in timber management areas (Lafferty 1987).

Brazier and Brown (1973) are quick to point out that the visual measure of angular canopy density does not adequately account for the true shading due to the different qualities of shade. The thicker canopies of the conifers are more efficient at screening solar radiation than the thin canopies of hardwoods, even though the measured canopy density may be the same. Other authors have pointed out that the Brazier and Brown technique needs to be modified for wide, north-south oriented streams (Pope and Lafferty 1987).

Another method that has proven to give accurate results under tight canopies, such as conifers or fully leafed deciduous vegetation, is reported in Platts et al. (1987) and adapted for this context. Measurements are made visually on randomly selected transects using a white disk 3 inches in diameter at approximately 100 points throughout the stream segment. Each reading is classified as being one of three states: direct sunlight, filtered sunlight, or shade.

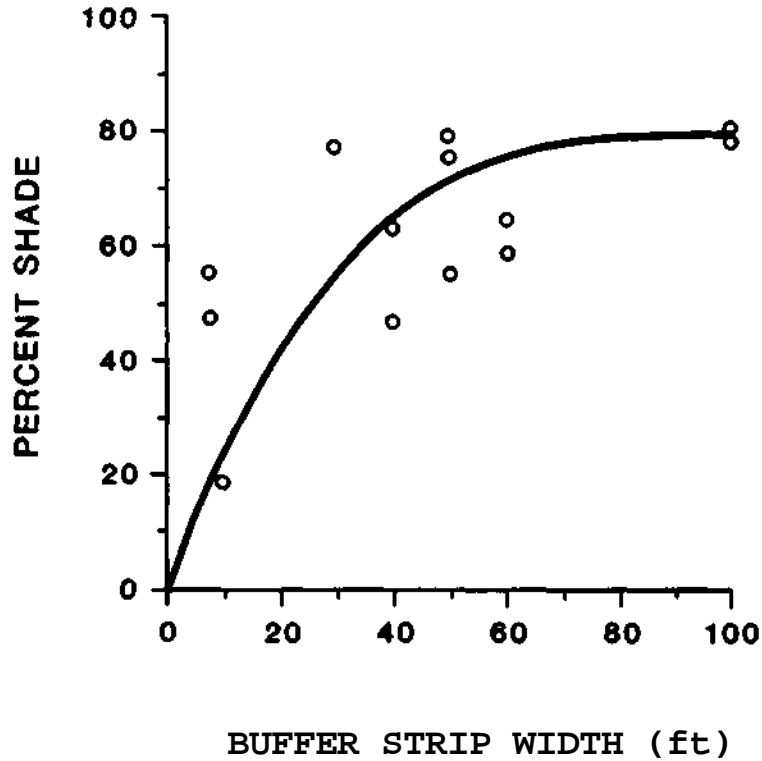

Figure 14. Influence of buffer strip width on shade density. As the buffer gets wider, the shade value reaches a "saturation" density. Adapted from Lafferty (1987).

The average shading would be determined by the formula:

$$\text{Mean Shade \%} = \frac{A(x) + B(y) + C(z)}{100}$$

where A = percentage of "full sun" observations

B = percentage of "filtered sunlight" observations

C = percentage of "shaded" observations

x = 100 (full sun)

y = 50 (filtered)

z = 7 (shaded)

For example, if 10% of the total observations were direct sun, 25% were filtered, and 65% were complete shade, the mean shade would be:

$$\text{Mean Shade \%} = \frac{10(100) + 25(50) + 65(7)}{100} = \frac{2705}{100} = 27\%$$

If you wish to be even more precise, instruments called pyrhelimeters or solarimeters may be obtained to measure direct-beam, short wave radiation. However, these instruments are expensive, and an acceptable alternative, though not as accurate because only visible light is being measured (Reifsnnyder and Lull 1965), is outlined below. This method is similar to one mentioned in the early literature (Shipman 1954), but uses even more readily available equipment and supplies.

Purchase from a photographic supply store an item called an 18% gray card (about \$5). Using an accurate, hand-held light meter or camera light meter, set the ASA value to a low number, such as 25. Set the f-stop to a high value, such as 16. Stand in direct sunlight and hold the gray card perpendicular to the sun's rays such that the meter readings are maximized. Hold the light meter about 6 inches from the gray card, so that the light meter only picks up light reflected from the gray card, being careful to cast no shadow on the gray card. Read the exposure-time from the meter; we will call the denominator of that exposure-time E_o . Now repeat the measurement in the shade, with the card held perpendicular to the path of the sun's rays through the vegetation, *without* changing the ASA or f-stop. This denominator we will call E_i . Then use the following formula to calculate the filtering effect:

$$\text{Shade quality} = 1.0 - (E_i / E_o)$$

For example, if the in-shade exposure-time is 1/50th of a second and the out-of-shade exposure time is 1/350th of a second, then

$$\text{Shade quality} = 1.0 - (50 / 350)$$

or

$$\text{Shade quality} = 0.86$$

You may need to experiment with the ASA and f-stop settings on your light meter such that you find a combination that adequately can take both in- and out-of-shade exposure-time measurements without changing the settings. (Similar measurements may be accomplished with a foot-candle meter if additional accuracy is desired.) The disadvantage of this method is that only the visible radiation is measured, and it may be difficult to accurately interpolate exposure times on the logarithmic scale. In addition, wind can create moving shadows, which confound point-in-time measurements. The advantage is that the sun need not be clearly visible, though the pair of measurements does need to be made under equal degrees of sunshine. Also, following the advice of Jackson and Harper (1955) and Wellner (1979), measurements should be taken between the hours of 0900 and 1500 at randomly or systematically selected sites in the stream, uninfluenced by topographic shading.

METEOROLOGICAL COMPONENTS

The simplest approach to data collection is to let someone else do it for you. There are a variety of sources for meteorological data. The list of candidates would include:

National Climatic Data Center (see Appendix A)
U.S. Weather Service
U.S. Department of Agriculture
 Experiment Stations
 Farm Forecast Services
 Forest Service Offices
 Forest Service Fire Data Center (see Appendix A and
 Furman and Brink (1975))
Private Weather or Data Services (see Appendix B)
Environmental Protection Agency Universities
Utility Districts/Companies
Airports
Military Installations - particularly the Air Force
Coast Guard

Perhaps the best organized data will be from the National Climatic Data Center. This data will be available in photocopy or magnetic tape form from them (NOAA 1985), but may be found in a more timely fashion at a local land grant university library. You should look for publications called Local Climatological Data, which come in two formats. The annual issue contains the monthly data summaries and normals (means for the previous 30 years); the monthly issue contains the daily summaries. Any other time period, e.g., weekly, must be assembled from daily data. A Summary of Hourly Data may be available at some stations, which may be useful in some situations. You also may be able to contract with a State climatologist to provide the data on diskettes. In one study that I know of, the climatologist provided daily values for air temperature, wind speed, dew point, and solar radiation, 1978-1986, for about \$300.

The data contained in the two most, common summaries is not entirely parallel (Table 4).

Other references that may prove useful, especially for data summaries, are Climatology of the U.S. (U.S. Weather Bureau 1960), which is good for frequency of very hot or cold days; Normal Weather Charts for the Northern Hemisphere (Dept, of Commerce 1952); Weekly Mean Values of Daily Total Solar and Sky Radiation (Dept, of Commerce 1949); and Sunshine and Cloudiness at Selected Stations in the United States (Dept, of Commerce 1951). Appendix E illustrates selected parameters for July conditions for the entire United States. This type of information is useful for doing "back of the envelope" calculations.

Though several problems arise in using this sort of data, two stand out as the most serious. The first is the issue of representativeness. The second is a more specific version of the first, dealing with elevation. Though I will discuss air temperature specifically, these problems are true to some degree for all of the meteorological data.

It is crucial that the air temperature data you use adequately represent your study area. If the readily available weather station data is from a large city and your study area is in the forested hills above the city, the air temperatures may not be representative. Similar considerations are ocean (or other large waterbody) proximity, topographic characteristics (slope), and

thermal inversions. Keep these issues in mind if you perform any sort of correlation between off-site data and spot on-site measurements, as recommended by some authors (Raphael 1962).

Table 4. Availability of useful data elements from two forms of Local Climatology Data Summaries.

Item	Annual (monthly data)	Monthly (daily data)
Maximum temperature	X	X
Minimum temperature	X	X
Average temperature	X	X
Normals	X	
Extreme temperature	X	
Wind speed	X	X
Percent possible sun	X	X
Relative humidity	X	
Dew Point		X
Station location	X	X

The second major problem involves the use of a single air temperature to represent all of the elevation zones in your study area. It has been common for streams being modeled to originate in the headwaters, perhaps with a reservoir in those headwaters, and flow through a large elevation change. It has proven inadequate to compute, or allow the model to compute, a single, translated air temperature. Lapse rates (the decrease in air temperature with increasing elevation) will themselves vary for the same reasons mentioned in the preceding paragraph, and at different times of the year.

For example, Leffler (1981) found variations in lapse rates of as much as 1.8 °C (3.2 °F) per kilometer between winter and spring. Figure 15 shows the frequency distribution of lapse rates measured in England over a 3-year period (cited by Geiger 1965). The adiabatic lapse rate is considered the standard and is the rate at which temperature changes with elevation such that the heat content remains the same. The figure shows that the median (50%) lapse rate measured is slightly smaller than the adiabatic rate. This begs the question to some extent, however, because the lapse rate we are interested in is that rate still at ground level with changing elevation, not going from ground level up into the air, the way it is most commonly measured.

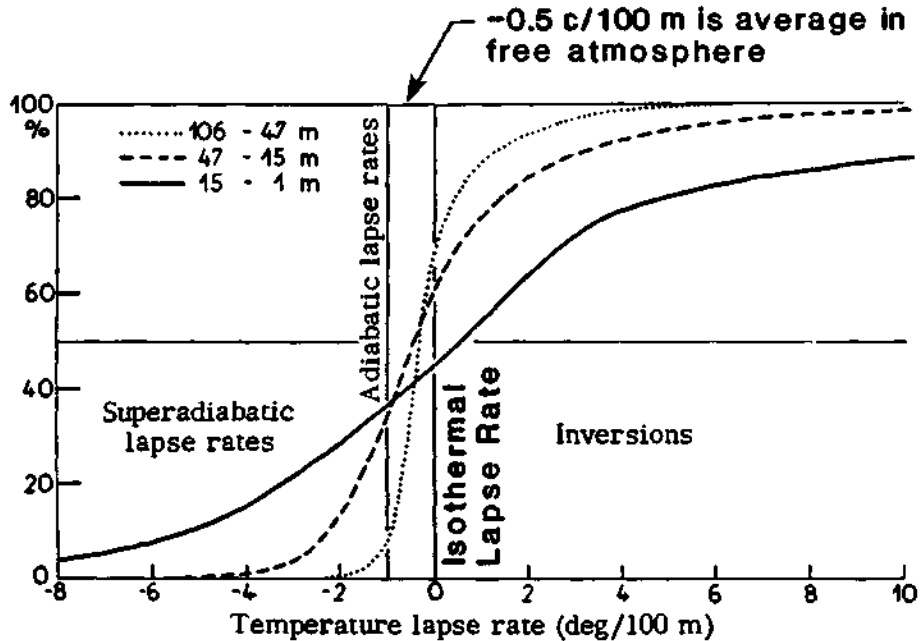

Figure 15. Frequency distribution of temperature lapse rates at different altitudes. Reproduced from Geiger (1965).

Both problems can be solved, or at least improved, by some form of on-site verification of air temperatures. If your study area is relatively homogeneous with respect to elevation, vegetation, land use, and orientation, a single site may be established for comparison with the known data set. A record length suitable for statistical correlation with the established station would need to be generated. If a large elevation change, or other non-homogeneity, is recognized, two air temperature stations would be recommended, such that some form of elevational correction or subarea modeling could be accomplished.

Each of the meteorological parameters will be discussed in detail. Keep in mind that establishing a "full blown" meteorological station (Figure 16) will cost \$3,500 or more just to install, with variable operating costs depending on the duration of the study and the frequency of data collection and checking. Further costs will be incurred for data reduction and quality control. Therefore, I will discuss each individual parameter so that options for varying the data collection effort may be evaluated. I will provide more detail for items that are either more important than others or which may be unfamiliar to most people.

If you are faced with establishing a more or less permanent, self-recording meteorological station, the following factors may be considered essential (Anderson 1955; Tenney 1987):

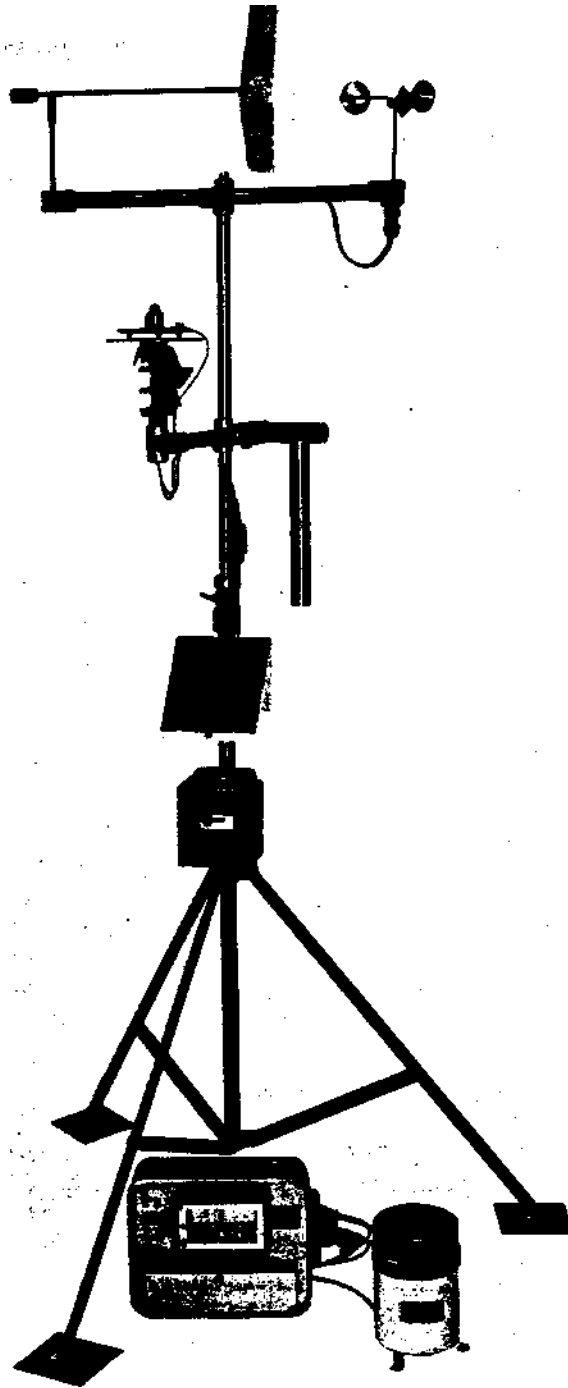

Figure 16. Field-installed meteorological station. These can be configured to collect almost any set of data imaginable, at a cost. Courtesy Climatronics Corporation.

1. The data must be recorded as accurately as possible, with a range covering the anticipated ranges encountered.
2. The equipment must maintain its calibration over extended time periods.
3. It must operate unattended for a long time, e.g., one month.
4. It must use a minimum of electrical power. Long-life batteries provide much more mobility.
5. All other things being equal, the smaller the size the better, so you can install (hide) it in more places, and the more rugged the better.
6. All other things being equal, data collected should be in the target units, with a visual display for checking.

In any such effort, a number of problems can be expected. Though old by current equipment standards, Anderson (1955) presents a figure from the then famous Lake Hefner Studies that illustrates many results (Figure 17). In this figure, "usable" refers to a level of hourly data collection that was deemed acceptable for this particular study. You will need to make your own standard for what is "usable." The "perfect" refers to no equipment malfunctions for an entire 24-hour day. This figure shows that data collection will likely improve with time and experience with the instrumentation. It also shows that data collection in the winter months is more likely to fail and will need increased frequency of attention to the equipment.

Appendix B lists some vendors from which permanent meteorological stations may be obtained.

Air Temperature

Crisp and Howson (1982) found that they could explain 86%-96% of the variance in water temperature by regressions containing solely mean air temperatures measured as far as 50 km away, as long as the air temperature was above freezing. Other authors (Smith and Lavis 1975; Song and Leung 1978) have noted the same profound linkage. Since air temperature is the single most important (sensitive) parameter in the absence of other thermal inputs, it deserves special attention and effort in getting data that is truly representative of the entire area being studied.

Air temperature is important because it plays a part in most of the heat flux components, especially atmospheric radiation, evaporation, and convection. As with all parameters needed to calibrate any water temperature model, air temperature data may come from a variety of sources. Air temperature may of course be measured in a manner much like that for water temperature. Thermometers ranging from simple mercury to digital thermographs are available at a wide range of prices.

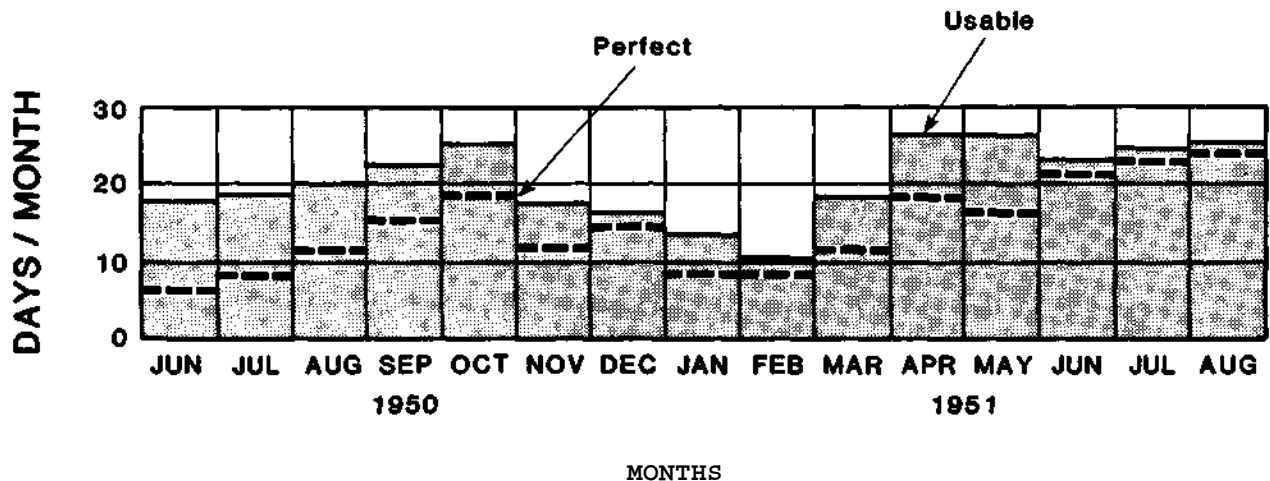

Figure 17. Variation of amount of usable data from self-installed meteorological stations. The shaded portion represents the number of days of usable data; the dashed portion represents the number of days of perfect data capture. Adapted from Anderson (1955).

One source of air temperature data, both maximum and minimum, is a database called CLIMATEDATA from U.S. West (see Appendices B and D). Unfortunately, this database does not contain other meteorological data needed by most temperature models. However, the sheer number of stations reported in this data base makes finding representative air temperature data a fairly easy task.

By convention, the primary weather stations record daily maximum and minimum air temperatures at midnight for the previous day, but not all stations adhere to this convention. It is prudent to check the source of your data for recording time. Rather serious biases, especially for mean monthly values, may occur otherwise. Any data problems may be compounded if you are trying to average values between stations or are taking some values from one station and some from another. If you suspect problems of this sort, see Blackburn (1983) for a method of correcting for observation time. You should be cognizant of things like Daylight Savings Time.

The mean annual temperature of cities averages about 1 °C above surrounding rural temperatures (Linsley et al. 1975); therefore, some additional correction may be in order. Using rural air temperatures may be more appropriate.

If you take or have available only daily maximum and minimum temperatures, it may be acceptable to simply take their average to determine the mean daily air temperature. This averaged value is usually less than a degree above the true daily average (Linsley et al. 1975). This is because the temperature variation is asymmetric; during the day it can be approximated by a truncated sine wave, but during the night it is more of a rapid exponential decay. You should always test your specific locale for deviation between the two means.

If there is a significant deviation, Parton and Logan (1981) have developed a method for determining hourly temperatures from daily maximum and minimums. Their method hinges on the use of three empirical coefficients known as a, b, and c (see the program in Appendix C). Ideally, such a model should be parameterized for these three coefficients, but their paper showed little sensitivity to changes in them. The a and c coefficients can be easily estimated for your site; the b coefficient should assume a value of about 2.1 (dimension-less). Using this routine to calculate the 24 hourly estimates and take their mean should give a better number for the daily average air temperature if (1) the maximum temperature occurs before or at sunset, and (2) the minimum occurs during the early morning hours.

The internationally accepted definition of microclimate refers to that layer of air from ground level (or water level in our case) to a height of two meters (Geiger 1965), which is the standard elevation for establishing climate shelters. More important is the relation between the height of the instrument and the river. Figure 18 shows the results from one Tennessee river experiment (Troxler and Thackston 1975). These results tend to justify using somewhat cooler air temperatures than typical measurements taken at dams or valley tops would provide.

The time of year associated with the most rapid changes in mean daily temperature are close to April 21 and October 23, one month later than the corresponding equinoxes (Blackadar 1984). This would be a time to pay closer than usual attention to air temperatures, especially for a daily, or smaller, time-step model.

Relative Humidity

Relative humidity, like air temperature, can be a very sensitive parameter. Also, like air temperature, relative humidity can be very different on site than at a long-established weather station miles away in a concrete jungle. We recommend that at a minimum, verification humidity measurements be taken twice a day for some period of time, either at 5 a.m. and 5 p.m. or 11 a.m. and 11 p.m., to be in sync with the NOAA data and allow comparative calculations if necessary.

A sling psychrometer may be used for spot measurements and for calibration checks on established recording stations. One can be purchased for

about \$50 from a forestry supply house, or one can be easily constructed.² The psychrometer results in two measurements, the wet and dry bulb temperatures.

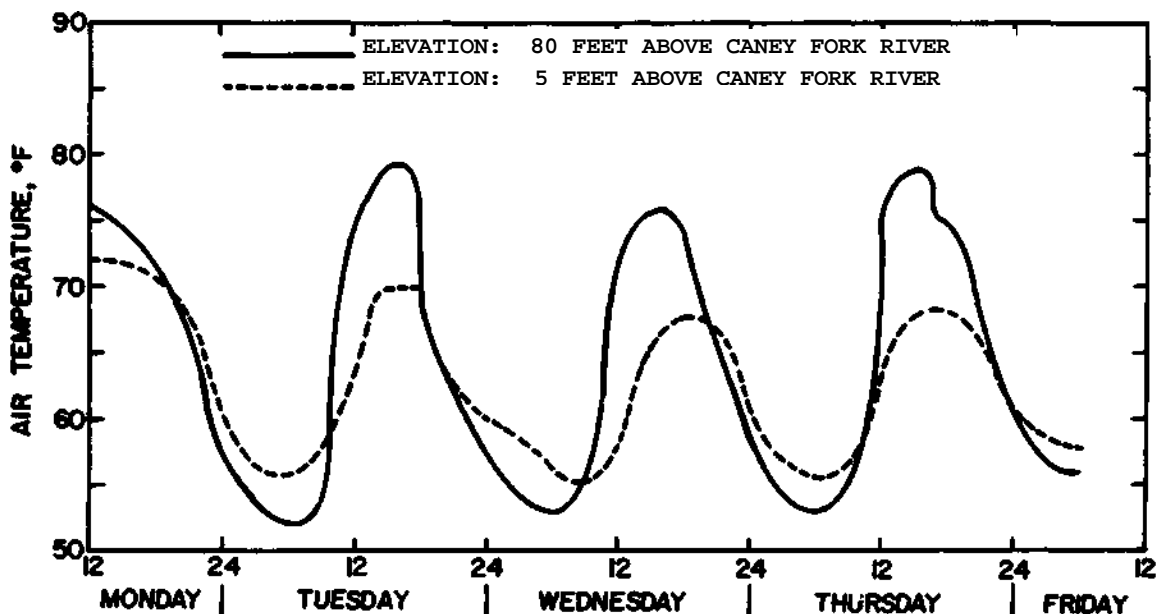

Figure 18. Variation of air temperature above the Caney Fork River, TN. This figure shows that near-water air temperatures are buffered from, and on average less than, air temperatures more representative of valley-top conditions. Reproduced from Troxler and Thackston (1975).

Convert the two temperatures to relative humidity with the program in Appendix C, which should run with little or no modification on any computer with BASIC. Simple hand calculations following the algorithms in the program would be sufficient also. As an example, if the wet-bulb temperature was 65.0 °F, the dry-bulb temperature was 59.5 °F, and the elevation was 1,000 feet above sea level, the relative humidity would be 73%.

If relative humidity is taken as part of an established recording weather station, you may not need to make forced air ventilation for the wet/dry bulb

²Glue two identical thermometers to a thin wooden paddle with the bulbs projecting from one end, one slightly more than the other. Drill a hole in the other end of the paddle and loop a sturdy piece of nylon twine through it such that the paddle can be twirled rapidly. Wrap a few layers of clean cloth or cotton string around the thermometer bulb that is mounted lowest on the paddle and affix with a rubber band. Dip this cloth in water and whirl the paddle around until the temperatures do not change. Read the temperatures quickly and accurately, to tenths of a degree if possible. The two readings are known as the wet-bulb and dry-bulb temperatures for obvious reasons (Blackadar 1983).

measurements, since out of doors the wind speed is rarely below 0.5 mph. The most common problem with humidity recording stations is freezing of the wet-bulb reservoir during the winter (Anderson 1955).

Often data other than relative humidity may be available. For example, one may find dew point instead of relative humidity. For these applications, you may need to refer to a set of tables published by the National Weather Service (1973). By knowing the dew point and air temperature (dry bulb), the relative humidity is determined. The published tables give the most accurate result, but are extremely tedious to use. A useful approximation, typically resulting in only a 0.6% error, may be found in Linsley et al. (1975) as:

$$Rh = [(112 - 0.1 TA + Tdp) / (112 + 0.9 TA)]^8$$

where Rh = relative humidity

TA = temperature of the air (dry bulb) °C

Tdp = dew point temperature °C

Like air temperature, relative humidity measured at the canyon top may not be representative of water surface humidity. Figure 19 (Troxler and Thackston 1975) shows this variation with height. This figure tends to justify the adjustment of relative humidity values by up to 20% from values taken off site.

Solar Radiation

Solar radiation is probably one of the most difficult and costly items to collect (properly) yourself. Unless local conditions dictate on-site data collection, I do not recommend tackling this job yourself. Though an important parameter, especially for maximum daily water temperature, it is relatively easy to estimate given other, more easily obtained, measurements. For example, either the SNTMP or SSSOLAR programs will estimate daily solar radiation for any specific time of year and set of conditions. The Cinquemani (1978) publication mentioned by Theurer is a good one, though hard to find.

Measurement will, of course, provide verification of such estimates, and if you do not feel that you can obtain representative estimates elsewhere, you may wish to measure solar radiation yourself. All radiation measuring instruments are called radiometers. There are a variety of species of radiometers, such as pyrradiometers, pyranometers, pyrgeometers, pyrliometers. The most common recording instrument used is simply called a pyranograph, available from meteorological or forestry supply houses for \$600 to \$1,000.

Most of these instruments work by measuring the temperature differential between differently reflective pieces of metal that are either fully or partially exposed to the sun's rays through a hemispheric window. Some use a silicon photocell as a sensing element. In either case, the mechanism produces an electrical current proportional to the solar radiation. They must be mounted on a level surface with a totally unobstructed view of the sky, horizon to horizon. In other words, they should not be influenced by local topography or vegetation—no shadows allowed. This may mean special problems in vandal-prone

areas. There are many potential problems with these units. Some problems unique to the pyranograph are things (snow, rain, leaves, dust) partially obscuring the window. Before ordering any such unit, pay careful attention to the units of measurement (e.g., gm cal. per sq. cm. or Langleys per min.), the method of obtaining the measurement (e.g., digital readout or planimentering a strip chart), and recommendations for calibration. For the "more than you wanted to know" report, refer to the comprehensive technical manual by Latimer (1972).

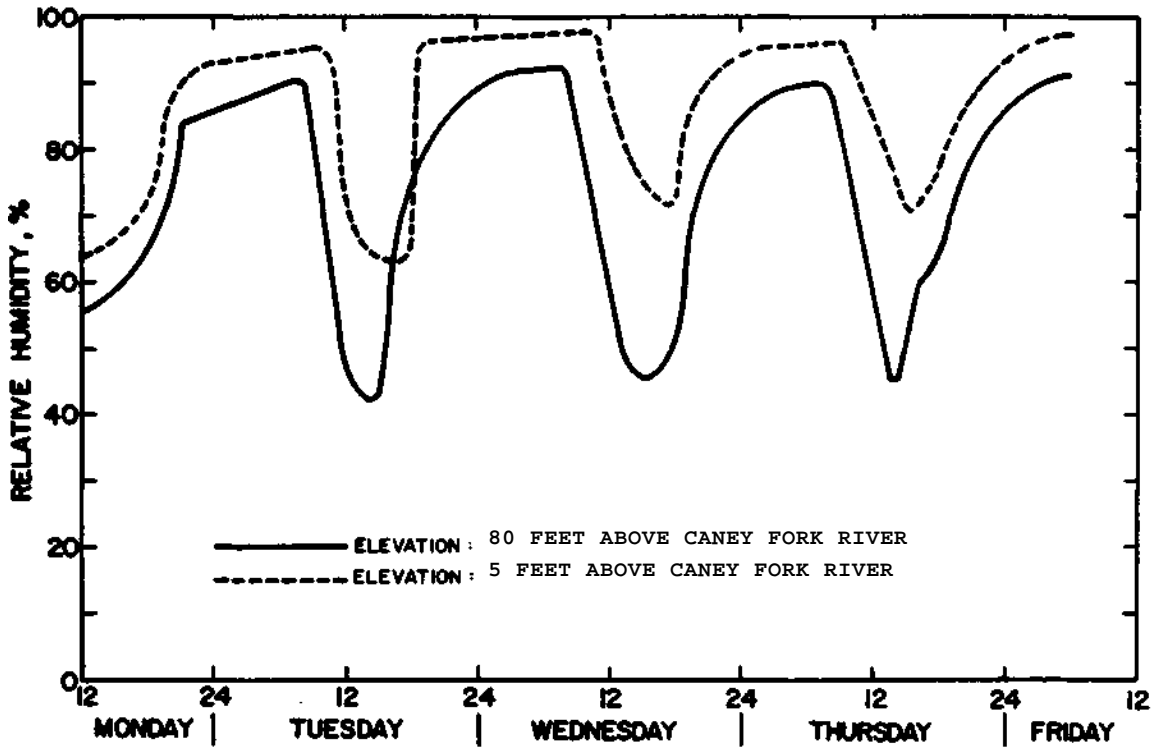

Figure 19. Variation of relative humidity above the Caney Fork River, TN. This figure shows that near-water humidity measurements are generally higher than (by almost 20%), and on average greater than, measurements more representative of valley-top conditions. Reproduced from Troxler and Thackston (1975).

Interestingly, you may find that some days will result in more solar radiation than is theoretically possible under clear sky conditions. This can occur if the instrument is receiving direct solar radiation as well as indirect solar radiation reflected from clouds that are not casting a shadow (Figure 20).

In the absence of solar radiation data, you may be able to estimate it by first calculating a "clear sky" value using the SSSOLAR program. Then use the percent possible sun measurements, if available, to scale the total radiation. Finally, scale these measurements once more, realizing that even at 0% possible sun, roughly 22% radiation still gets through. For example, suppose you calculate a clear sky radiation value for the time of year and latitude to be 300 kilojoules/square meter/second. The "completely clouded sky" value would

thus be 22% of 300, or 66. Records indicate 75% possible sun; so 75% of the value from 66 to 300 would be approximately 240 kilojoules/square meter/second.

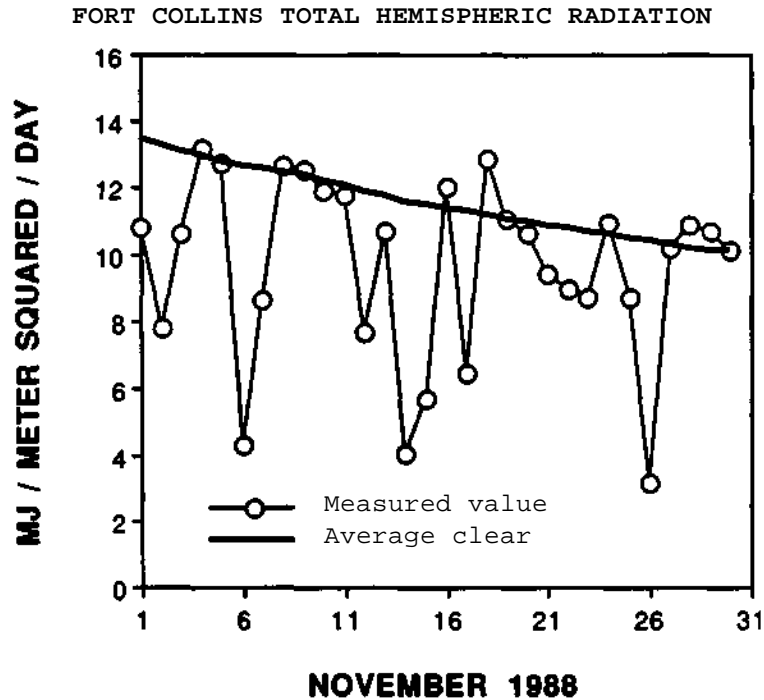

Figure 20. Total hemispheric radiation taken at Fort Collins, CO, during December 1988. Note the days in which radiation exceeds the clear day value. From Colorado Climate Center (1988).

Percent Possible Sun

Percent possible sun is used in the SNTMP models as a surrogate for cloud cover. This measurement is taken at more weather stations than is solar radiation, but it is probably subject to more error. Technically, percent possible sun is measured as the number of minutes of direct sunlight divided by the number of minutes possible for that latitude and time of year. Obvious problems arise in determining the threshold of cloud cover at which the sun "ceases to shine." The technical specification calls for a limit of 200 watts/square meter, but like the radiation measurements, dust, rain, snow, and other factors literally "cloud" the instrument at times.

There is a relatively new instrument on the market called a Sunshine Recorder, which costs about \$1,100. It works by burning a trace on a chart that is at the focus of a hemispherical lens.

When not measured by an instrument, percent possible sun is periodically estimated by a weather observer. Estimates of cloud cover are likely to be

either missing or in error at night. Since percent possible sun is used as a surrogate for cloud cover, those measurements that are taken may not be good estimates for nighttime conditions, especially in areas with marked diurnal weather patterns.

None of these measurements really get at the "quality" of the cloud cover. Cirrus and nimbus clouds provide markedly different types of solar radiation attenuation and atmospheric reradiation. In short, percent possible sun estimates may be a good candidate for model calibration. In other words, if you have poor estimates, treat them with the uncertainty they are due.

Wind

Though wind direction is not important in the stream temperature models, speed is. Wind is perhaps most important in convective and evaporative heat flux. Wind is the meteorological parameter that one would least like to translate from off-site; the effects of topography on wind are too varied and complex (Geiger 1965). An exception might be for biweekly or monthly time steps. On shorter time steps, if you cannot measure wind speed, use it as a calibration parameter. In other words, you may vary wind speed in the models within some reasonable bounds to effect a better match between observed and simulated water temperatures. Some water temperature models use wind speed almost exclusively as a calibration parameter (Laenen and Hansen 1985).

A variety of devices are available for measuring wind speed. Unlike standard meteorological measurements, however, we are not interested in anemometer measurements from a 12 or 20 foot tower. Wind speed should be measured near the water's surface, subject to the typical constraints (soil banks, riparian vegetation) at that level. Because of air turbulence near the water's surface, the wind speed there is seldom less than 1 m/s (Krajewski et al. 1982). See also Figures 21 and 22, which show the effects of shelter belts (i.e., riparian vegetation) on wind speed. These figures may be useful if timber harvest is a management action.

Available wind speed data may be from a standard 10 m (30 ft) anemometer tower. Under certain circumstances it may be desirable to try to correct for the observation height. Linsley et al. (1975) presents a formula for this:

$$\frac{V_h}{V_m} = \frac{\ln[(z_h/z_0) + 1]}{\ln[(z_m/z_0) + 1]}$$

where V_h = velocity at desired height, cm/s

V_m - velocity at measured height, cm/s

z_h = height desired, suggest 10 cm

z_0 = roughness length, suggest 10 cm

z_m = height of measurement, cm

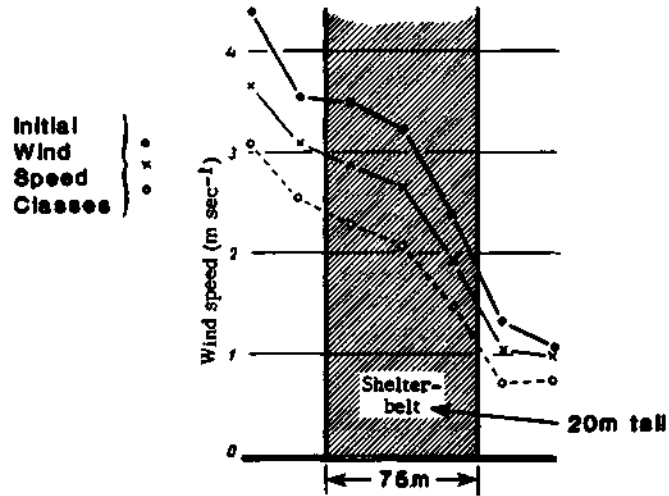

Figure 21. Effect of a shelter belt on various wind speed classes. Reproduced from Geiger (1965).

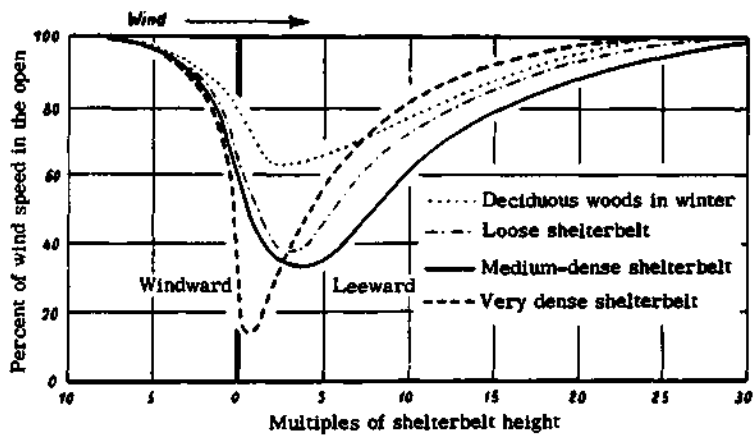

Figure 22. Effect of various shelterbelt heights on wind speed. Reproduced from Geiger (1965).

It has been theorized that wind speed affects solar reflectivity by altering the water surface roughness and introducing air bubbles near the surface. (The same thing has been postulated for roughness caused solely by stream gradient.) However, Raphael (1962) mentions that the widely cited Lake Hefner studies failed to find any relationship between wind speed and reflectivity. Also, experimental data has shown insensitivity of surface reflectance to the water's purity and turbidity (Viskanta and Toor 1972).

Ground Temperature

Ground temperature typically is an insensitive parameter in water temperature modeling. Though not strictly speaking a meteorological parameter, ground temperature is so strongly influenced by the long-term meteorology that it might as well be. In the absence of other data, we generally assume that ground temperature is the same as the mean annual air temperature. This assumption is very nearly true for moderate depths (approximately two feet) in Fort Collins, Colorado (Figure 23). One can, however, spot seasonal trends that show the lag time from surface temperature to differing depths. Another study, in Vienna (cited by Geiger 1965), showed ground temperature at a depth of 1.9 meters to be 1 °C higher than the mean annual air temperature over a period of 33 years.

There may be occasions when you feel that the assumption of mean annual air temperature is incorrect, such as in a geothermal area, or where the aspect of local topography thoroughly influences the input of solar radiation to the ground (Figure 24), or because of local soil/rock characteristics. If so, it would be good to verify the ground temperature.

Direct measurement of ground temperature will be nearly impossible for any given study because ground disturbances due to drilling or digging are too disruptive to the temperature profile. In fact, it can take up to 10 years for temperature profiles in the ground to stabilize completely after a disturbance. For this reason, it would be far better to check for sources at weather stations or agricultural experiment stations than to attempt measurement yourself. Since we are interested in ground temperature below the stream surface, these reported temperatures may not be representative. Groundwater temperature from shallow wells near the stream may be more appropriate. Similarly, temperature of discharging springs may be a good source for both ground temperature and lateral inflow temperature.

Ground Reflectivity

The ground reflectivity (percent) is a measure of the amount of shortwave radiation reflected from the earth into the atmosphere. Representative values may be taken from Table 5 (Geiger 1962; Gray 1970; Tennessee Valley Authority 1972) without being too concerned with accuracy due to the relative insensitivity of this parameter.

FORT COLLINS SOIL TEMPERATURES (°F)
 MAIN CAMPUS, AVERAGE OF 7 A.M. AND 7 P.M.
 VALUES, 1977-1984

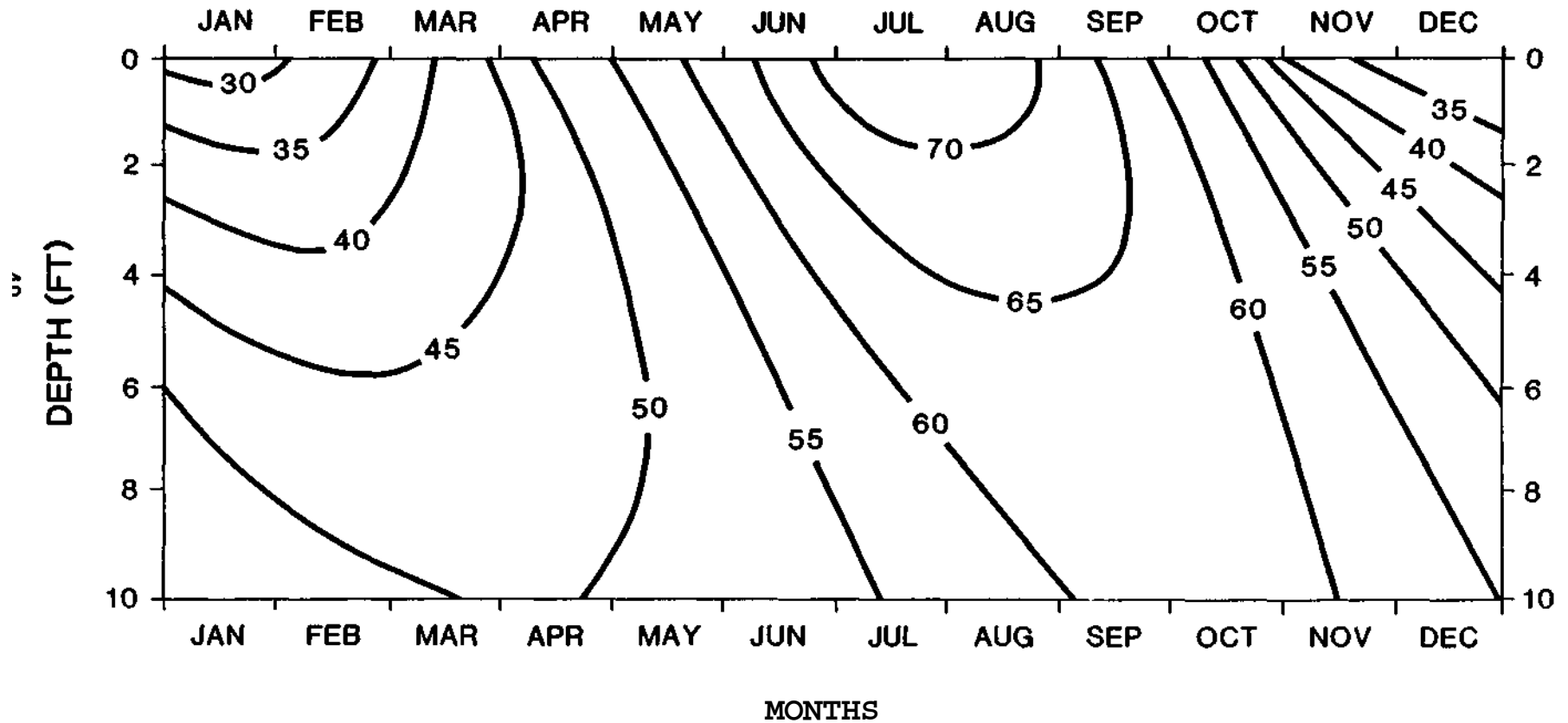

Figure 23. Annual variation of ground temperatures at Fort Collins, CO. Climate Center, Colorado State University.

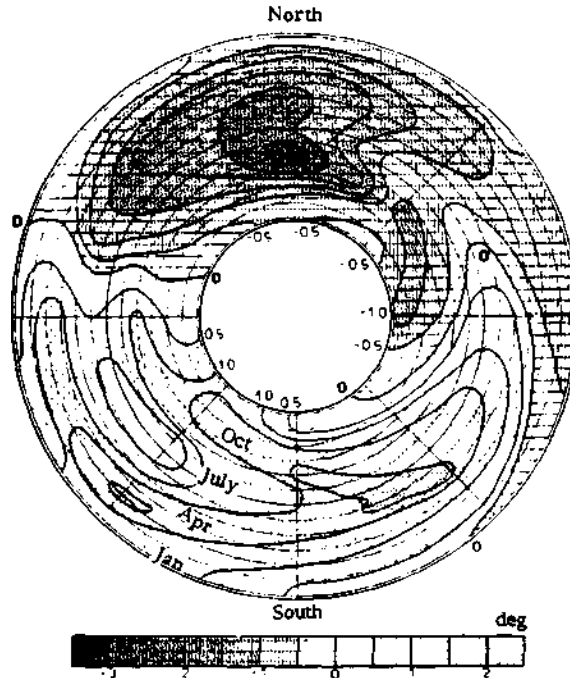

Figure 24. Departure from the mean ground (70 cm) temperature ($^{\circ}\text{F}$) according to direction of slope and time of year. This illustrates the fact that different topographic conditions may result in markedly different subsurface (groundwater) temperatures. Reproduced from Geiger (1965).

Dust Coefficient

This parameter is one that probably should have been left out of the SNTMP family of models. There is no good direct way to measure this index to the scattering effect that dust and other small particles have on incoming solar radiation. Theurer et al. (1984) show how to perform a solar radiation calibration to arrive at reasonable values for both ground reflectivity and the dust coefficient. A similar, but more straightforward approach would require good estimates for cloud cover, air temperature, and ground-level solar radiation and a best guess for ground reflectivity. The SSSOLAR program then may be used to estimate what the dust coefficient must be to produce the ground-level solar radiation.

Table 5. Percent reflectivity for various homogeneous ground cover conditions.

Setting	Percent
Meadows and fields	12 to 30
Leaf and needle forest	5 to 20
Dark, extended mixed forest	4 to 5
Heath	10
Flat ground, grass covered	15 to 33
Flat ground, rock	12 to 15
Light cultivated soil	15 to 30
Dark cultivated soil	7 to 10
Sand	10 to 20
Sandy soil	15 to 40
Light sand dunes, surf	30 to 60
Vegetation, early summer	19
Vegetation, late summer	29
Fresh snow	80 to 90
Old snow	60 to 80
Melting snow	40 to 60
Clean glacier granular snow	50 to 65
Dirty glacier granular snow	20 to 50
Ice	40 to 50
Clean glacier ice	30 to 46
Dirty glacier ice	20 to 30
Water, lakes	5 to 15
Water, sea	3 to 10
Densely urban areas	15 to 25

Day Length

Day length is such a well-known measurement that it hardly bears mentioning. The SNTMP programs will calculate day length automatically, or Table 6 may be used for a good estimate.

HYDROLOGY COMPONENTS

I will only touch on collecting hydrologic data, since this subject is covered adequately in other available publications (Bovee and Milhous 1978; Bovee 1982; Hamilton and Bergersen 1984). This is not to minimize the need for accurate flow measurements, both surface and groundwater; though not typically the most significant variables, they can play a major role in affecting stream temperatures.

Table 6. Day length (hrs) for various time frames and latitudes. Adapted from Forsythe (1954).

Approximate declination of the sun:	-23 27'	-15	-10	-5	0	+5	+10	+15	+20	+23 27"
Approximate date:		Feb 9 Nov 3	Feb 23 Oct 19	Mar 8 Oct 6	Mar 21 Sep 23	Apr 3 Sep 10	Apr 16 Aug 28	May 1 Aug 13	May 20 Jul 24	Jun 21
Latitude	hours	hours	hours	hours	hours	hours	hours	hours	hours	hours
0	12.12	12.12	12.12	12.12	12.12	12.12	12.10	12.10	12.12	12.12
10	11.53	11.75	11.88	12.00	12.12	12.23	12.35	12.48	12.62	12.72
20	10.92	11.38	11.63	11.87	12.12	12.37	12.62	12.88	13.13	13.35
30	10.20	10.97	11.35	11.73	12.13	12.52	12.90	13.32	13.75	14.08
40	9.33	10.43	11.02	11.58	12.15	12.72	13.27	13.88	14.53	15.02
50	8.07	9.72	10.58	11.38	12.20	12.98	13.78	14.65	15.62	16.38
55	7.17	9.25	10.27	11.23	12.20	13.18	14.13	15.18	16.40	17.38
60	5.87	8.60	9.88	11.05	12.25	13.42	14.58	15.90	17.50	18.88
65	3.57	7.70	9.35	10.83	12.28	13.75	15.23	16.97	19.27	22.05
70		6.23	8.53	10.48	12.35	14.23	16.22	18.73		
80			3.17	8.77	12.63	16.73				

Discharge

The discharge for many rivers may be obtained through the U.S. Geological Survey, which maintains a network of gaging stations throughout the United States. Normally, gages are located on the larger streams and rivers and may not be available in smaller watersheds. Typically, discharge measurements will reflect mean daily or mean monthly flows; further manipulations would be required for any other time-step. Other sources for discharge measurements include the HYDRODATA database (see Appendix D), Soil Conservation Service, NAWDEX, water conservation or irrigation districts, national parks and forests, utilities, and some city water departments. The HYDRODATA source may also include reservoir stage and reservoir storage, though these are much less frequently found.

Users of SNTMP have advised that studies in which either reservoirs or powerhouses are involved will usually necessitate the evaluation or reduction of historical operations records, as well as the identification of possible future operations. This can result in a significant expenditure of time and manpower, usually complicated by incomplete and inconsistent data formats (Dave Gilbert, Pacific Gas and Electric, pers. comm.).

If historical discharge measurements are not available, some form of field measurements must be made. Since discharge is greatly influenced by the characteristics of the channel, it is advisable to carefully select transects for homogeneity. Be sure to establish a staff gage in accordance with recommended procedures (Bovee and Milhous 1978) if a temperature study is coupled with a PHABSIM analysis. Taking enough discharge measurements will allow correlation with discharges in well-measured watersheds. Thus, the historical record may be extended back in time (Bovee 1982). Consult an experienced hydrologist if in doubt.

Most network-type temperature models will require that flow data be supplied for internal geographic locations for which you have no measurements. In cases for which you can assume no changes in groundwater or tributary inflow, or a stream that is losing flow, the discharge for an arbitrary point between two other points of known discharge is:

$$Q_x = Q_1 + (Q_2 - Q_1) * \frac{(D_x - D_1)}{(D_2 - D_1)}$$

where Q_x = unknown discharge at point x, between 1 and 2

Q_1 = known discharge at location 1

Q_2 = known discharge at location 2

D_x = distance measurement at location x

D_1 = distance measurement at location 1

D_2 = distance measurement at location 2

For example, discharges at km 7 and 12 are known to be 50 and 55 cms, respectively. The discharge at km 10 is estimated by:

$$Q_{10} = 50 + (55 - 50) * \frac{(10 - 7)}{(12 - 7)} = 50 + 5 * 3/5 = 53 \text{ cms}$$

Note that this formulation could be applied on a drainage-area basis Instead of distance basis.

Groundwater

Since it is usually impossible to measure irregularities in groundwater discharge either into or out of a stream, you must assume that the rate of gain or loss is uniform between points of known or calculated instream discharge. Most models, including SNTEMP, will calculate this for you, but some will not.

As with all other data elements, if you have reason to believe that groundwater inflow is not uniform, such as in areas of complex geology, and that the temperature of the discharge is markedly different from that of the stream, further investigation is necessary. A crude sensitivity analysis may demonstrate whether this is warranted. See the section on microthermal habitats and references for some ideas. No particular attention need be given if the stream is a losing stream (groundwater recharge).

WATER TEMPERATURE COMPONENTS

Existing Data

Getting your hands on existing water temperature data would usually be the first choice in most temperature studies. Often a quick perusal of the existing data will tell you whether, or how often, extremes have been reached. Occasionally, this may be all you need. However, existing data typically may not let you construct any relationship between flow and stream temperature. More importantly, existing data will *not* be sufficient to describe what will take place in the face of changing the system in some way.

Water temperature data is collected by a wide variety of State and Federal agencies. A publication by the USGS Office of Water Data Coordination (Pauszek 1972) attempted to tabulate all the agencies involved. Though undoubtedly out-of-date, this publication is useful as a summary of data availability. It tabulates the agencies by State, and partitions the collections by lakes, reservoirs, canals, estuaries, drains, springs, and wells, as well as the frequency of measurements. This publication does not present any data; however, it does contain a 194-reference bibliography of sources that do.

The Federal agencies that collect water temperature data are given as:

USDA Forest Service
Army Corps of Engineers
National Marine Fisheries Service

Bureau of Reclamation
Environmental Protection Agency
Federal Energy Regulatory Commission
Fish and Wildlife Service
Geological Survey
Naval Facilities Engineering Command
Atomic Energy Commission
International Boundary & Water Commission
Tennessee Valley Authority

The State agencies are too numerous to list individually because the names vary slightly by State. However, a general categorization would be:

Water Resources Departments Game
and Fish Departments Public Health
Departments Pollution Control
Departments Sanitary Engineering
Departments Water Quality Control
Departments Water Districts State
Geological Surveys Utilities

Out of 7,500 stations collecting surface water temperature data, about 4,500 were Federal and 3,000 were State. Most (over 4,000) were east of the Mississippi, and most of these were in the Great Lakes States. Of the stations in the West, most measurements were in the three coastal States. These statistics are not so impressive when frequency of measurement is considered. Continuous water temperature measurements were made at only 731 stations, largely concentrated in Washington, Oregon, and California. Continuous measurement is not needed in groundwater temperature measurements, however.

Examples of commonly available formats for obtaining daily water temperature data from USGS are shown in Tables 7a, 7b, and 7c, and from STORET in Table 8. Appendix D contains some examples of formats available from the HYDRODATA database. (This data base also may contain some isolated humidity, solar radiation, air temperature, and wind speed data.) Make sure that no changes have occurred in the system that would have affected water temperatures if you use historical data. Dams, irrigation diversions, or channelization are examples of things to look for (Hamilton 1984). Historical USGS water temperature measurements are generally considered accurate within plus or minus 1 °F (.56 °C) 80% of the time, and within 2 °F (1.1 °C) about 95% of the time according to Moore (1967); this may be better today, but I have no supporting evidence. Also, temperature gaging stations immediately downstream from a dissimilar tributary may give erroneous measurements due to incomplete lateral mixing. This will likely be true at gaging stations that have had temperature measurement added to existing stage measurement capabilities. Mixing must be present during all seasons; fluctuating tributary conditions, as found with snowmelt, can result in incomplete mixing during part of the year.

Table 7a. Alternative forms in which you may find water temperature data in USGS publications or databases: a daily values summary showing availability of temperature data through space and time.

DAILY VALUES SUMMARY													
RETRIEVAL NUMBER 1.00													
CROSS SEC	PARM	STAT	BEGIN	END	NO.	MISSING							
STATION NUMBER	CODE	CODE	YEAR MO	YEAR	MO	DAYS	DAYS	YEARS	MAXIMUM	MINIMUM	MEAN		
BOISE RIVER NR TWIN SPRINGS	ID	AGENCY USGS	STATE	16	DISTRICT	16	COUNTY	015	SITE	SW DR	AREA =	830.00	SQ MI
13185000	00010	00001	1955 3	1957	9	661	42	3	22 .00	0.00	8.51		
13185000	00010	00001	1977 6	1979	9	701	29	3	25 .70	0.10	9.21		
13185000	00010	00002	1955 3	1957	9	661	42	3	19 .50	0.00	6.58		
13185000	00010	00002	1977 6	1979	9	701	29	3	20 .40	0.10	6.80		
13185000	00010	00003	1977 6	1979	9	701	29	3	22 .90	0.10	8.03		
13185000	00010	00011	1958 10	1959	9	365	0	1	24 .50	0.50	8.59		
S FK BOISERIVER NR FEATHERVILLE ID			AGENCY USGS	STATE	16	DISTRICT	16	COUNTY	039	SITE	SW DR	AREA =	635.00 SQ MI
13186000	00010	00001	1962 12	1965	9	973	62	3	25 .59	0.59	9.45		
13186000	00010	00001	1977 5	1977	9	226	19	2	24 .00	0.50	14.22		
13186000	00010	00001	1978 3	1979	9	574	36	2	23 .19	0.10	11.06		
13186000	00010	00002	1962 12	1965	9	973	62	3	18 .30	0.59	6.54		
13186000	00010	00002	1977 5	1977	9	226	19	2	18 .30	0.10	9.57		
13186000	00010	00002	1978 3	1979	9	574	36	2	17 .60	0.00	7.14		
13186000	00010	00003	1977 5	1977	9	226	19	2	20 .90	0.30	11.94		
13186000	00010	00003	1978 3	1979	9	573	37	2	19 .80	0.10	9.10		
S FK BOISE RIVER AT ANDERSON RANCH DAM ID			AGENCY USGS	STATE	16	DISTRICT	16	COUNTY	039	SITE	SW DR	AREA =	982.00 SQ MI
13190500	00010	00001	1977 5	1979	9	897	17	4	17 .19	2.60	8.05		
13190500	00010	00002	1977 5	1979	9	897	17	4	16 .10	2.00	6.65		
13190500	00010	00003	1977 5	1979	9	897	17	4	16 .40	2.40	7.22		
S FK BOISE R AT NEAL BRIDGE NR ARROWROCK DAM ID			AGENCY USGS	STATE	16	DISTRICT	16	COUNTY	039	Site	SW		
13192200	00010	00001	1977 5	1979	9	895	19	4	19 .90	-0.20	9.71		
13192200	00010	00002	1977 5	1979	9	895	19	4	15 .40	-0.20	6.91		
13192200	00010	00003	1977 5	1979	9	895	19	4	17 .60	-0.20	8.23		
MORES CREEK AB ROBIE CREEK NR ARROWROCK DAM ID			AGENCY USGS	STATE	16	DISTRICT	16	COUNTY	015	SITE	SW DR	AREA =	399.00 SQ MI
13200000	00010	00001	1964 12	1964	12	14	17	1	1 .69	0.59	0.78		
13200000	00010	00001	1965 3	1967	9	829	115	2	27 .79	0.00	10.69		
13200000	00010	00001	1968 12	1969	8	235	39	1	26 .99	0.00	9.61		
13200000	00010	00001	1970 1	1972	9	908	35	3	25 .59	0.00	8.95		
13200000	00010	00002	1964 12	1964	12	14	17	1	1 .09	0.00	0.50		
13200000	00010	00002	1965 3	1967	9	829	115	2	23 .89	0.00	8.39		
13200000	00010	00002	1968 12	1969	7	213	30	1	20 .99	0.00	5.51		
13200000	00010	00002	1970 1	1972	9	908	35	3	21 .09	0.00	6.17		
13200000	00010	00003	1967 10	1968	9	412	46	2	22 .00	0.00	7.81		
13200000	00010	00003	1969 9	1969	9	28	2	0	19 .39	13.89	17.16		
13200000	00010	00011	1969 10	1970	9	438	19	2	20 .00	0.00	7.75		

Table 7b. Alternative forms in which you may find water temperature data in USGS publications or databases: daily maximum, mean, and minimum water temperature values.

UNITED STATES DEPARTMENT OF INTERIOR - GEOLOGICAL SURVEY PROCESS DATE IS 09-06-77

STATION NUMBER 02197370 SAVANNAH R. BL STEEL CR NR MILLETVILLE, S.C. STREAM SOURCE AGENCY USGS

LATITUDE 330458 LONGITUDE 0813554 DRAINAGE AREA DATUM STATE 45 COUNTY 005

TEMPERATURE (DEG. C) OF WATER, WATER YEAR OCTOBER 1974 TO SEPTEMBER 1975

DAY	MAX	MIN	MEAN	MAX	MIN	MEAN	MAX	MIN	MEAN	MAX	MIN	MEAN
1	21.0	20.0	21.0	24.0	23.0	23.5	24.0	23.5	24.0	26.0	25.0	25.5
2	22.0	20.5	21.0	24.0	23.0	23.5	24.5	24.0	24.5	26.0	25.5	25.5
3	22.5	21.0	21.5	23.5	23.0	23.5	25.0	24.0	24.5	26.5	25.5	26.0
4	22.5	21.0	22.0	23.0	22.5	23.0	25.5	24.5	25.0	26.5	25.5	26.0
5	20.5	20.0	20.0	23.5	22.5	23.0	26.0	25.0	25.5	25.5	25.0	25.5
6	20.0	19.5	20.0	23.5	22.5	23.0	26.0	25.0	25.5	25.5	24.5	25.0
7	20.5	20.0	20.0	23.0	22.5	23.0	25.5	24.0	25.0	25.5	24.5	25.0
8	22.0	20.5	21.5	23.5	22.5	23.0	24.0	23.5	24.5	25.0	24.5	25.0
9	22.5	21.5	22.0	24.0	23.0	23.5	24.0	23.0	23.5	25.5	24.5	25.0
10	22.5	22.0	22.0	23.5	22.5	23.0	24.0	23.5	23.5	26.0	25.0	25.5
11	22.5	22.0	22.5	22.5	21.5	22.0	24.0	24.0	24.0	25.5	25.0	25.5
12	22.5	22.0	22.0	22.5	21.5	22.0	25.0	24.0	24.5	25.5	24.5	25.0
13	22.5	22.0	22.5	22.0	22.0	22.0	25.5	24.5	25.0	25.0	23.5	24.5
14	22.5	22.0	22.5	22.5	21.5	22.0	25.5	25.0	25.5	23.5	22.5	23.0
15	22.5	22.0	22.0	22.5	22.0	22.0	25.5	25.5	25.5	22.5	21.5	22.0
16	22.5	22.0	22.5	22.5	22.0	22.0	26.0	25.5	25.5	22.0	21.5	21.5
17	23.0	22.5	23.0	22.0	21.5	21.5	26.0	25.5	25.5	22.5	22.0	22.0
18	23.5	23.0	23.0	22.5	21.5	22.0	26.0	25.5	26.0	22.5	22.0	22.0
19	23.5	22.0	22.5	23.5	22.0	22.5	26.5	25.5	26.0	23.0	22.5	22.5
20	22.5	21.5	22.0	24.0	21.5	23.0	26.5	26.0	26.0	24.0	23.0	23.5
21	23.5	21.5	22.5	24.0	23.5	23.5	26.0	25.5	26.0	24.0	23.5	23.5
22	23.0	22.0	22.5	24.5	24.0	24.0	25.5	25.0	25.5	24.0	23.5	24.0
23	23.0	22.5	22.5	25.0	24.0	24.5	26.0	25.0	25.5	25.0	24.0	24.5
24	23.0	22.5	22.5	25.0	24.5	25.0	25.5	25.5	25.5	25.0	24.0	24.5
25	23.0	22.0	22.5	24.5	23.5	24.0	26.5	25.5	26.0	24.0	23.5	23.5

(Continued)

Table 7c. Alternative forms in which you may find water temperature data in USGS publications or databases: daily mean water temperatures.

PLATTE RIVER BASIN

0676400 SOUTH PLATTE RIVER AT JULESBURG, COLO.--Continued

EXTREMES, 1970-71 -- Continued

Water temperatures: Maximum, 21.0°C Aug. 22, 23; minimum, freezing point on many days during December to March. Period of record.--Specific conductance: Maximum daily, 3,270 micromhos Jan. 12, 1971; minimum daily, 348 microhoms Aug. 15, 1968. Water temperature (1946-49, 1950-71): Maximum, 34°C July 28, Aug. 1, 1953, July 7, 18, 1963; minimum, freezing point on many days during winter period.

REMARKS.--Samples for specific conductance and temperature collected from channel no. 2 (06783990). For monthly chemical analyses considered applicable to this site, see record for South Platte River near Julesburg, Colo. (sta. 06764200).

TEMPERATURE (°C) OF WATER, WATER YEAR OCTOBER 1970 TO SEPTEMBER 1971

DAY	OCT	NOV	DEC	JAN	FEB	MAR	APR	MAY	JUN	JUL	AUG	SEP
1	14.5	4.5	4.5	1.0	1.0	3.5	6.5	10.0	8.0	11.0	10.0	11.0
2	12.0	3.5	2.0	0.0	0.0	2.0	12.0	4.5	9.0	14.5	14.5	12.0
3	14.5	2.0	3.5	0.0	1.0	1.0	10.0	5.5	10.0	10.0	9.0	15.5
4	13.5	3.5	1.0	0.0	0.0	4.5	6.5	5.5	9.0	13.5	8.0	10.0
5	13.5	3.5	1.0	0.0	0.0	4.5	5.5	4.5	8.0	11.0	8.0	15.5
6	13.5	4.5	4.5	0.0	0.0	4.5	12.0	2.0	10.0	11.0	8.0	20.0
7	9.0	10.0	3.5	1.0	0.0	0.0	9.0	2.0	6.5	12.0	6.5	14.5
8	4.5	5.5	2.0	0.0	0.0	0.0	14.5	4.5	9.0	8.0	8.0	5.5
9	5.5	4.5	3.5	0.0	1.0	8.0	15.5	4.5	8.0	10.0	8.0	11.0
10	8.0	4.5	1.0	0.0	4.0	8.0	11.0	4.5	8.0	9.0	14.5	5.5
11	8.0	9.0	1.0	0.0	3.5	6.5	10.0	1.0	8.0	15.5	9.0	8.0
12	6.5	6.5	1.0	0.0	2.0	4.5	12.0	2.0	10.0	11.0	10.0	10.0
13	10.0	8.0	0.0	0.0	4.0	8.0	15.5	4.5	9.0	10.0	10.0	4.5
14	9.0	4.5	0.0	0.0	5.5	2.0	11.0	4.5	8.0	10.0	18.0	4.5
15	5.5	2.0	2.0	0.0	5.5	3.5	18.0	4.5	5.5	13.5	9.0	4.5

(Continued)

Table 7c. (Concluded)

TEMPERATURE (°C) OF WATER, WATER YEAR OCTOBER 1970 TO SEPTEMBER 1971												
DAY	OCT	NOV	DEC	JAN	FEB	MAR	APR	MAY	JUN	JUL	AUG	SEP
16	4.5	3.5	0.0	1.0	4.5	4.5	14.5	10.0	5.5	10.0	10.0	4.5
17	12.0	4.5	1.0	0.0	3.5	10.0	15.5	9.0	10.0	11.0	10.0	3.5
18	8.0	8.0	1.0	1.0	4.5	4.5	15.5	4.5	10.0	13.5	11.0	9.0
19	10.0	8.0	0.0	0.0	4.5	1.0	13.5	2.0	12.0	8.0	10.0	9.0
20	9.0	2.0	0.0	1.0	3.5	4.5	13.5	4.5	12.0	9.0	10.0	4.5
21	10.0	4.5	0.0	1.0	1.0	5.5	15.5	10.0	11.0	10.0	9.0	13.5
22	10.0	3.5	0.0	1.0	0.0	4.5	10.0	8.0	14.5	9.0	21.0	10.0
23	10.0	0.5	0.0	1.0	0.0	2.0	9.0	5.5	12.0	9.0	21.0	6.5
24	9.0	2.0	0.0	1.0	0.0	1.0	13.5	4.5	14.5	9.0	9.0	10.0
25	9.0	4.5	0.0	0.0	5.5	1.0	10.0	5.5	14.5	10.0	10.0	12.0
26	5.5	4.5	0.0	2.0	3.5	12.0	4.5	5.5	13.5	6.5	12.0	11.0
27	5.5	4.5	1.0	0.0	0.0	14.5	6.5	5.5	11.0	8.0	10.0	12.0
28	6.5	4.5	0.0	4.5	0.0	4.5	9.0	5.5	10.0	8.0	15.5	13.5
29	9.5	3.5	1.0	2.0	—	9.0	11.0	6.5	9.0	6.5	11.0	11.0
30	12.0	4.5	1.0	4.5	—	8.0	3.5	6.5	10.0	4.5	11.0	13.5
31	4.5		0.0	1.0		15.5		5.5		6.5	10.0	

Table 8. One form in which you may find water temperature data from the STORET data base.

```

STORET RETRIEVAL DATE
                                06701500
                                39 12 33.0 105 16 02.0 2
                                SOUTH PLATTE RIVER BELOW
                                08059    COLORADO

/TYPA/AMBNT/STREAM
                                112WRD    790519    10190002
                                0000 FEET DEPTH

                                00010    00011

DATE      WATER      WATER
FROM      TEMP      TEMP
TO        CENT     FAHN

82/07/06  1030      8.00000    46.4000

82/07/20  1115      8.00000    46.4000
78/07/11      11.0000    51.8000
78/07/24      12.0000    53.6000
79/07/16      13.0000    55.4000
84/07/19  1240      17.0000    62.6000
83/07/28  1110      17.5000    63.5000
80/07/15  1120      18.0000    64.3999
79/07/02      19.0000    66.1999
84/07/02  1255      19.0000    66.2000
80/07/03  1250      19.5000    67.0999
97/07/01

MONTH     NUMBER      16      16
          MAXIMUM    19.5000  67.0999
          MINIMUM    6.00000  42.8000
          MEAN      12.0937  53.7687

97/07/31
78/08/21      4.50000    40.1000
81/08/03  0930      6.00000    42.8000
81/08/17  0900      6.50000    43.7000
81/08/31  0905      6.50000    43.7000
80/08/12  0950      6.50000    43.7000
79/08/13      7.00000    44.6000
79/08/27      8.50000    47.3000
80/08/27  0945      9.00000    48.2000
82/08/16  1235     10.5000    50.9000
78/08/08     12.5000    54.5000
82/08/30  1325     14.0000    57.2000
82/08/03  1255     14.5000    58.1000
83/08/11  1050     16.5000    61.7000
83/08/25  1150     17.0000    62.6000
84/08/29  1305     18.5000    65.3000
84/08/16  1235     20.0000    68.0000
84/08/1 H  »5      20.0000    68.0000
97/08/01

MONTH     NUMBER      17      17
          MAXIMUM    20.0000    68.0000
          MINIMUM     4.50000    40.1000
          MEAN      11.6471    52.9646

97/08/31

```

Water temperature data obtained from other sources should always be somewhat suspect. Independent verification may be in order by limited field sampling. After all, the whole basis for any temperature model calibration/validation assumes that the observed temperatures are measured accurately and without bias.

Instrumentation

Thermographs of all types are readily available from several vendors (see Appendix B), and most decisions relate to how many instruments are to be deployed at a time, initial and incremental costs of each instrument, and personal preference. Many people, for example, still prefer strip chart or film type recorders. They are relatively inexpensive, reasonably rugged, and commonly available. Their biggest problems, being mechanical instruments, come from failure of moving parts, drying of ink, and torn media. Also, they may not have a wide enough recording range for a multiseason study.

Digital recorders are newer devices that clearly represent the trend in temperature measurement (Gile 1986). They come with their own set of advantages and disadvantages. Usually more expensive (e.g., \$950) than thermographs, digital recorders store readings in some form of memory (called RAM or EPROM); they have better accuracy, little need for calibration, and are smaller and lighter, but they require microcomputer involvement to get your data "out." Some of these units require batteries to "remember" their data, and some do not. The battery units are typically less expensive, but battery problems can and do happen. So called nonvolatile units will at least remember what they have stored before a battery problem arises. One must either take a micro to the field, be willing to swap units, be without a unit for a time, or purchase more expensive units with swappable memory chips. With digital recorders there is typically no need to send anything for off-site digitizing or other data reduction technique.

Before you buy, draft a set of specifications (Table 9).

No matter whether analog or digital units are used, one also has the choice of in situ or remote placement. In situ is probably preferable in streams where vandalism is a concern, but in situ placement runs a greater risk of loss of the unit in high water, physical damage, leakage, or being covered with silt or debris. In situ also requires a "dunk" to install, test, and replace the unit. In contrast, a remotely mounted unit with a cable leading to a thermistor requires clever concealment, but it is more easily serviceable and requires a less costly housing, weatherproof rather than waterproof (Figure 25).

Table 9. Example thermograph specifications.

Requirements	Suggested criteria
Temperature range	At least 0 to +50 °C (32 to 122 °F)
Resolution	At least 0.1 °C (0.18 °F)
Accuracy	At least +/- 0.3 °C (0.54 °F)
Recording method	Digital with visible readout
Interface	RS-232 compatible with IBM microcomputer
Battery life	At least 1 year
Measurement capacity	At least 4380 (6 months of hourly samples) recordings
Measurement interval	Selectable, at least 30 minutes and 1 hour
Deployment	Both submersible (waterproof) for in situ recording and by remote cable (water resistant)
Size	Minimal
Weight	Minimal

Lifton (Woodward-Clyde, pers. comm.) listed problems with the units he has used and arrayed them from most to least common:

1. Theft
2. Vandalism
3. Leakage
4. Battery failure
5. Chart jam or malfunction
6. Stylus jam or breakage
7. RAM failure
8. Chip pin damage or breakage
9. Analog to digital converter failure
10. Tape or film failure

All of these problems may be mitigated to some degree by how often you visit the instrument. Once every two weeks to begin with, and then once a month, may be reasonable, but this is highly dependent on local conditions, desired redundancy in your data, and cost.

More complex studies may make it necessary to collect other water quality data at the same time as water temperature data. Refer to other sources such as Bark et al. (1986), Benham and George (1981), Hamilton (1984) and Appendix B for more information and references.



Figure 25. In situ and remotely configured thermographs.

Occasionally, spot measurements may be used in lieu of continuous recorders. Moore (1967) outlined techniques for reconstructing annual temperature cycles by regressing spot temperature measurements, if date and time of observation are known, with continuous measurements on similar streams. He found that seasonally stratified regressions produced better results than entire-year regressions as streams became more dissimilar. For example, lumping May, June, September, and October in one group, November to April in another, and July and August in a third produced good results.

Moore also reviewed previous investigators' methods for obtaining mean daily water temperatures, for example, averaging the 9 a.m. and 9 p.m. versus 8 a.m. and 4 p.m. temperature measurements. He reported that averaging the daily maximum and minimum temperatures gave an acceptable mean, with a probable error of only 0.3 °C (.54 °F). In the context of our previous discussion of averaging max and min air temperatures, averaged water temperatures should be checked at your site for deviations from true 24-hour means.

Site Selection

There are several considerations that go into decisions on how many and where temperature recording instruments should be placed. The "how many" is often based on cost. Figure 26 illustrates the relative priorities for establishing stations in different system configurations. Obviously, the first priority is to accurately measure stream temperatures within the river reach(es) of biological importance (Figure 26a). This (single) location will also suffice for calibration purposes. Beyond this first priority, the picture becomes cloudy, with lots of intervening variables; nevertheless, we can make some generalizations. In general, the next priority must be assigned to reservoir release temperatures (Figure 26b), since all temperature models require these starting water temperatures. In some cases, if it is known that reservoir release temperatures are relatively constant, at least through the season of concern, actually measuring that temperature through time may not be as important. Further, as the distance from important biological sites to a reservoir becomes large (greater than 30 km), the need for release temperature measurements decreases. In such cases, equilibrium release temperatures may suffice. This is not to say that you should not measure the release temperature; however, if time, money, and manpower are limiting, this may be an area where data can be sacrificed. Use the segment temperature model to test system sensitivity.

In a situation where there is no reservoir, headwaters are the logical candidate. It could be argued, however, that headwaters sufficiently far upstream (greater than 30 km) can just as easily be approximated by using the "zero flow headwater" approach. If there is a reservoir and one or more other "major" tributaries (Figure 26c), it could be argued that knowing the temperature immediately above the junction may be more important than knowing the reservoir release temperature, again considering the relative distances involved. That is, if there is no area of biological concern above the junction, we do not care as much about the temperature profile in the upper reaches. If, however, the release temperature fluctuates dramatically, or more importantly, release temperature is a management action to be evaluated, placing a recorder at that location should dominate (Figure 26d).

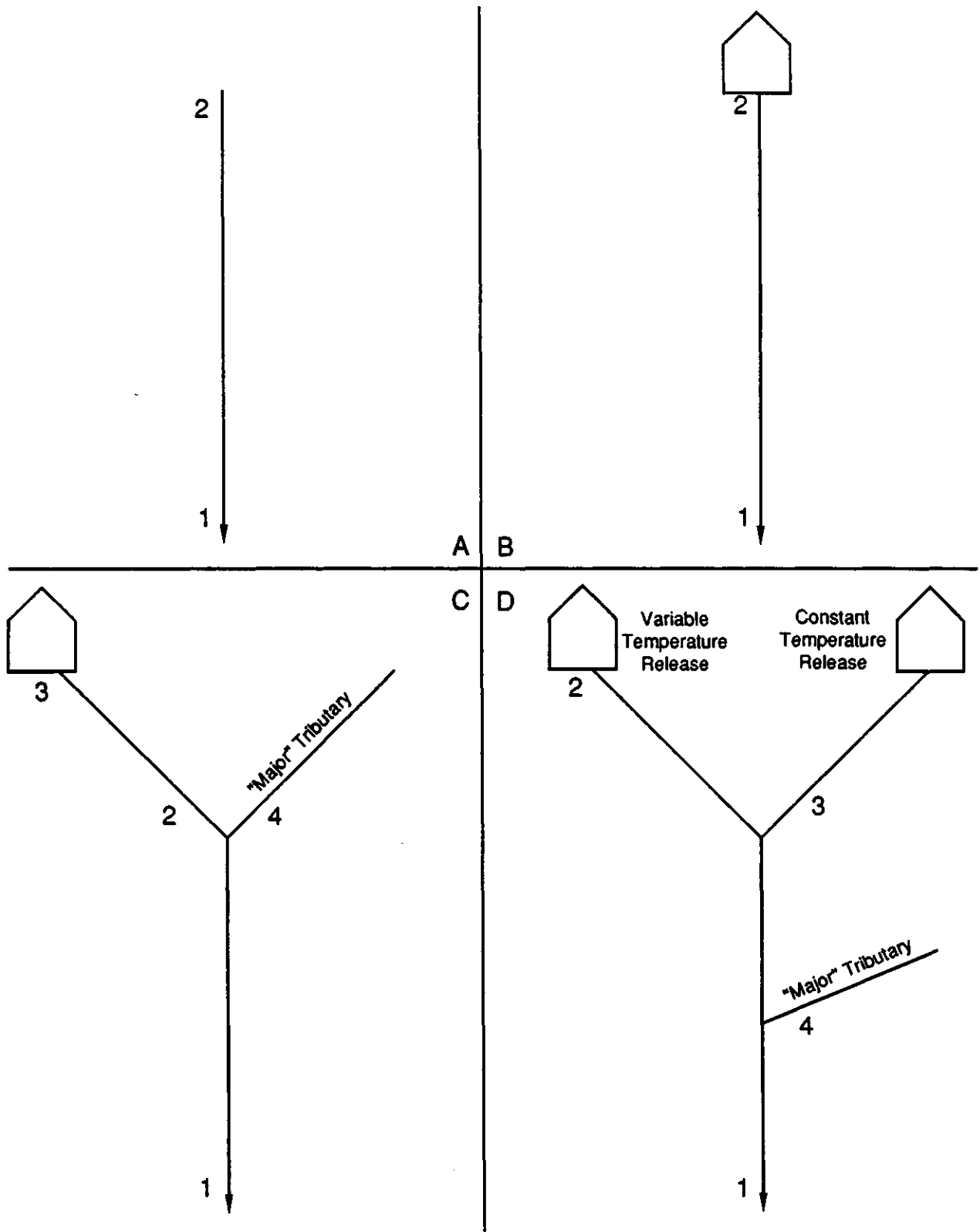

Figure 26. Priorities for installation and collection of water temperature monitoring locations for various stream network configurations. See text for explanation. After Lifton (pers. comm.).

For our purposes, a "major" tributary should not be defined by the standard 10% of the mainstem flow rule [note that Nobel and Jackman (1980) believe that a 5% discharge rule should apply], but rather by a temperature change definition. For example, a tributary that changes the temperature of the mainstem by more than 5% should be included. The mixing equation may be used to estimate temperature change. One must think ahead, however, for a tributary may not presently be changing mainstem temperatures, but it may do so under altered or post-project conditions.

Beyond these general rules, one can only say the more temperature locations the better; more provides insurance against inevitable downtime and lost data. A greater instrument density will also help you isolate troublesome reaches for which the models seem to perform poorly. However, more monitoring stations also add to the cost. I can think of no case in which the density of recorders needs to be greater than every 5 km along a mainstem, all other things being equal; this should be adequate for small (less than 50 cfs) streams. For larger rivers, 10 km may be adequate.

The exact installation site along a river is usually out of your control; physical accessibility (e.g., private land) or the existing location of streamflow gages may essentially dictate the site. When a station is established, care must be taken to ensure the site is suitable for measuring temperature on a more detailed level. For example, water temperature of reservoir outflow may be measured within the scroll case of one or more turbines. These temperatures, however, may be significantly higher than the average for the total outflow, due to stratification in the forebay, heat generated by turbulence, and heat conducted through the turbine shaft and dam. Therefore, it may be best to measure at a distance far enough downstream to ensure complete mixing. Verify this by taking a temperature profile, both vertically and horizontally, preferably at low flow. If a particular site requires a monitoring station, and there is documented horizontal or vertical variation of more than 2 °C (3.6 °F) more than 5% of the time, two stations should be installed. In cases of highly variable temperatures (Figure 27), it may be necessary to calculate a discharge weighted mean temperature as discussed by Stevens et al. (1975).

The sensor itself is usually mounted in a perforated pipe directly in the streamflow, but protected to minimize physical damage. The sensor should not rest in direct contact with the streambed, nor should it be in direct sunlight, if possible. Obviously, erroneous measurements will result if the sensor gets exposed to air at low flows or gets covered with silt or other debris. Location too near any slough or stilling well can cause erroneous measurements if the water level fluctuates very much (Stevens et al. 1975).

Calibration

I recommend that any temperature measurements taken have some tie to a recognized standard, such as that provided by the American Society for Testing and Materials (ASTM). The use of such a standard will help assure uniformly high quality data in the courtroom and establish a basis for better comparisons in the literature (which is woefully inadequate in presenting information regarding exactly what kinds of temperature measurements were taken).

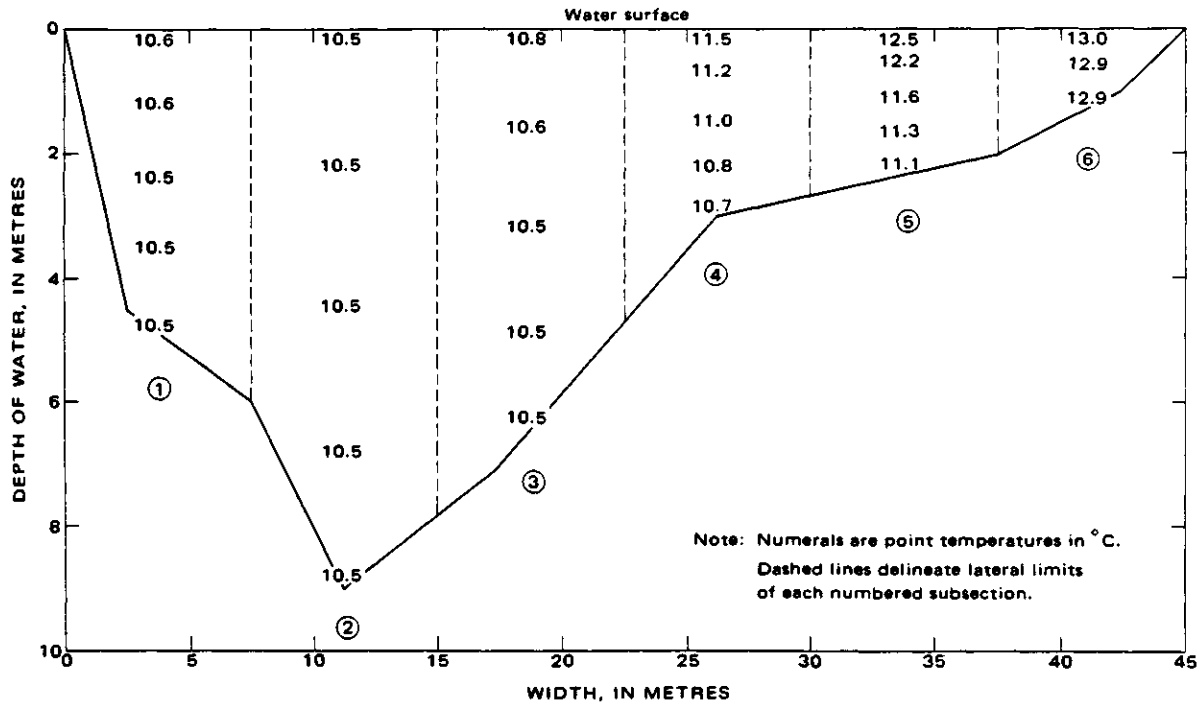

Figure 27. Cross-sectional temperatures showing degree of temperature variation for a given transect at a given flow. Reproduced from Stevens et al. (1975).

Standard thermometers are calibrated for use by what are known as "total" immersion, "complete" immersion, or "partial" immersion instruments. The needs of taking temperature calibration measurements are best met with the total immersion thermometer (ASTM 1983a). In this case, proper calibration requires that you either totally immerse the mercury column or use a correction factor equation. For most water temperature applications, the calibration thermometer of choice is the ASTM 63C, chosen because of its appropriate range and units (-8 to +32 °C, 17.6 to 89.6 °F), its graduation scale (0.1 °C, 0.18 °F), and its maximum scale error (0.1 °C, 0.18 °F). If you can get by with a somewhat smaller scale (0 to 30 °C, 32 to 86 °F), the model 90-C may be a better choice, as it needs to be immersed to only 76 mm. See ASTM (1983b) for a thorough description of the options available and ASTM (1983c) for more complete definitions. ASTM 63-C or 90-C thermometers are available from several vendors for about \$50 (see Appendix 6). You would be wise to purchase two.

The thermometer used for calibrating other instruments should be lightly tapped against a resilient surface prior to use to eliminate small separations in the mercury column. If substantial separations still exist, an ice bath may be used to draw all of the mercury into the bulb (ASTM 1983a). Unfortunately, this procedure is not readily adaptable to field conditions, where it may be

better to carefully heat the bulb to totally fill the capillary tube and then allow gradual cooling. For special problems in using these thermometers in arctic conditions see Osterkamp (1979).

The frequency of calibration will vary with the instruments used and must be determined by the experience of the operators. Stevens et al. (1975) outlined the methods for instream and air temperature measurement and calibration. His method is reported here with minor modifications to be slightly more contemporary (technology continues to improve these devices).

1. Measure air temperature in the shade using a dry thermometer to minimize the risk of obtaining an erroneously low air-temperature reading due to evaporation.
2. Select a site in the stream where the water is moving and where the influence of tributaries is diminished because of mixing. Studies have shown that a temperature taken in the main flow of the stream is usually representative of the entire water mass. During the summer, when discharges are low, it may be necessary to wade into the center of the stream, or as far as possible in deep streams, to obtain the temperature. If sufficient mixing has not occurred, temperature observations must be obtained at several locations so that a discharge-weighted mean temperature can be computed.
3. Stand so that a shadow is cast upon the site chosen for collecting the temperature.
4. Make certain the liquid column in the thermometer is not separated. Hold the thermometer by its top, and totally immerse it in the water in the shadow area. Position the thermometer so that the scale can be read, and hold the thermometer in the water until the liquid column no longer moves (no less than 60 seconds).
5. Without removing the thermometer from the water (to avoid wet-bulb cooling), read the temperature to the nearest 0.1 °C (0.18 °F), and record it in the field notes. [Temperatures measured by the calibration thermometer should be read in a fashion to eliminate parallax (ASTM 1983a).] If the water is too rough or too turbid to allow a reading in the stream, the temperature may be taken by filling a container with the water, immersing the thermometer in the container, and then reading the temperature. The container must be large enough to allow total immersion of the thermometer, and the walls of the container must be brought to the same temperature as the stream before it is filled with water for temperature determination. In addition, it must provide sufficient thermal mass to insure that the temperature of the water in the container does not change while the temperature is being recorded. A volume of at least a pint should be withdrawn for temperature measurement.

The observed water temperature is considered to be the true stream temperature and will be designated as TST. The next step is to repeat the above procedure (steps 3 through 5) in the water near the

sensor. This is not the sensor temperature but the temperature of the water mass surrounding the sensor, and it will be designated as TNS (temperature near sensor). After recording this temperature the observer should check the thermograph recorder and note the indicated temperature. The recorder temperature is designated as TRC. The three temperatures should all be recorded in the field notes and also on the temperature chart (if there is one), along with the date and time. Differences between TST and TNS will generally be diurnal or seasonal in nature. The recorder should, hence, be set to read TNS, and corrections should be made during the analysis of the record to account for differences between TNS and TST. This recording procedure will provide a clear record of problems at a given site, and it permits the recording of accurate temperatures at the higher flows, when TNS is likely to be representative of the true stream temperature (TST). Usually, changes in a recorder setting of less than 0.5 °C (0.9 °F) should not be made unless the apparent error is verified by two or more field inspections.

After the observer has obtained and recorded the three reference temperatures, she should check and correct, if necessary, the recorder-chart time and the zero and span settings. Sensors should be checked, cleaned, and replaced if necessary. Sensor-recorder measuring systems should be recalibrated at least twice each year (more often if problems are observed).

Groundwater Temperature

Many streams receive substantial portions of their flow for all or part of a year from groundwater. Obviously, it is important to have a good estimate on the temperature of this advective thermal contribution. In many cases, the diurnal temperature fluctuation may be almost completely damped out in spring-fed streams, especially in large or heavily shaded streams (Moore 1967). Localized influx of cool groundwater may account for temperature reductions of 4-5 °C (7.2 to 9 °F) over a distance of 300 m in small streams (Smith and Lavis 1975).

Stevens et al. (1975) recommends using a maximum-minimum thermometer for measuring ground-water temperatures at a reconnaissance level. This seems quite practical, since in most cases groundwater would not be expected to fluctuate in temperature very much. Other measures would need to be taken should variation be observed. These temperatures may be taken in unused wells, pumping (irrigation) wells, discharging springs, mines, or holes bored in the streambank. Wells present special problems if there is much stratification.

In the absence of on-site groundwater temperature measurements, Theurer (1984) and Currier and Hughes (1980) recommend the use of mean annual air temperature. Moore (1967) confirms this approximation with the exception of thermal areas.

There seems to be an unfortunate lack of information about the temperature of irrigation return flow. One source (Sylvester 1963) reports the following

sketchy information for the Yakima River basin, which is not meant to be representative of other locales. To paraphrase:

Irrigation return flow temperatures may be warm or cool depending on the situation. The storage of irrigation water in deep reservoirs generally provides a cooler source to river points above major diversions. Below these diversions, water is diverted resulting in about 20% loss due to spillage and over-irrigation. The rest is applied to irrigated land where it evapotranspires (roughly 40% of the diverted water) resulting in a cooling of the soil. About 45% of the water enters the groundwater where one half of this returns to the parent stream during the irrigation season and one half returns from bank storage during the non-irrigation season. In either event, part returns to the stream in open drainage channels or subsurface drains. Open drains resulted in temperature rises of about 3.3 °F (1.8 °C). Sub-surface drains display a drop of about 5.3 °F (2.90 °C). Thus the proportion of water returning by each method may be important.

For this reason, the SNTEMP model allows for proportioning this lateral flow. For SNTEMP, Theurer (1984) recommends estimating the open drain return temperature as equilibrium temperature; the remainder may be estimated as ground-water temperature.

Data Correction and Reduction

There are a number of problems that arise in reducing temperature data. If your data is obtained from an external source, it may be wise to apply the so-called "maximum-minimum test" (Moore 1967). This comparison follows the logic that the maximum water temperature on any day (or really any time period) cannot be less than the minimum temperature on the preceding or following days because the temperature cannot change instantaneously. Since rounding errors may be present, only discrepancies of more than the minimum resolution should be scrutinized. Always ask for and test data in the original units to minimize rounding and reporting errors.

The sources for error in your own data reduction, particularly in analog recording devices, such as strip chart recorders, are many and varied (Figure 28). The constant error is the most common and can be corrected by adding or subtracting the bias. Nonuniform errors require at least two-point calibration. Both types of errors may be compounded if it is known that drift over time has occurred. If so it is usually assumed that the drift rate has been constant. I recommend that you keep a log of calibration checks so that these errors may be corrected. Cold water temperatures are known to affect some mechanical recorders. These errors should be considered uncorrectable unless some correlation with a properly functioning recorder is possible.

Most field temperature recorders now have some automatic or semi-automatic method of generating a computer readable digital file of temperature measurements. At worst, a strip or circular chart must be sent to a lab for digitizing. At best, there is software available for summarizing already digitally recorded data. However, you should check beforehand to see whether the

digitizing or other software has built-in methods for correcting the constant or drift errors mentioned above.

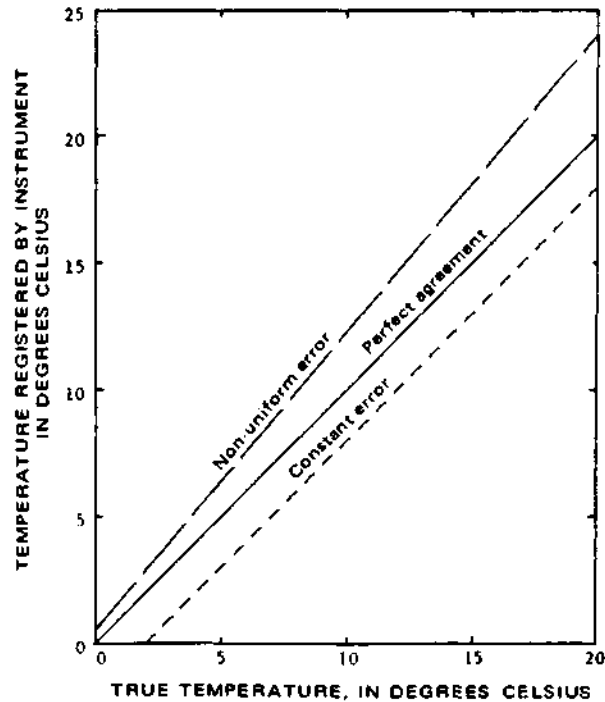

Figure 28. The different types of error that can arise in the measurement of temperature. If well specified, these types of errors can be corrected (calibrated). Reproduced from Stevens et al. (1975).

The methods of summarizing and presenting water temperature data can vary from simple to complex and depend largely on the purposes at hand. In general, graphical techniques are valuable in showing the degree of variation over time or space (Figure 29).

If daily average temperatures are reported, the maximum and minimum temperatures should also be recorded if the diurnal variation is greater than about 2 °C (3.6 °F) (Stevens et al. 1975). Dates and times should always accompany periodic or nonrecording measurements. Remarks concerning accuracy of measurements or other special considerations also should be included for a comprehensive tabulation of temperature measurements.

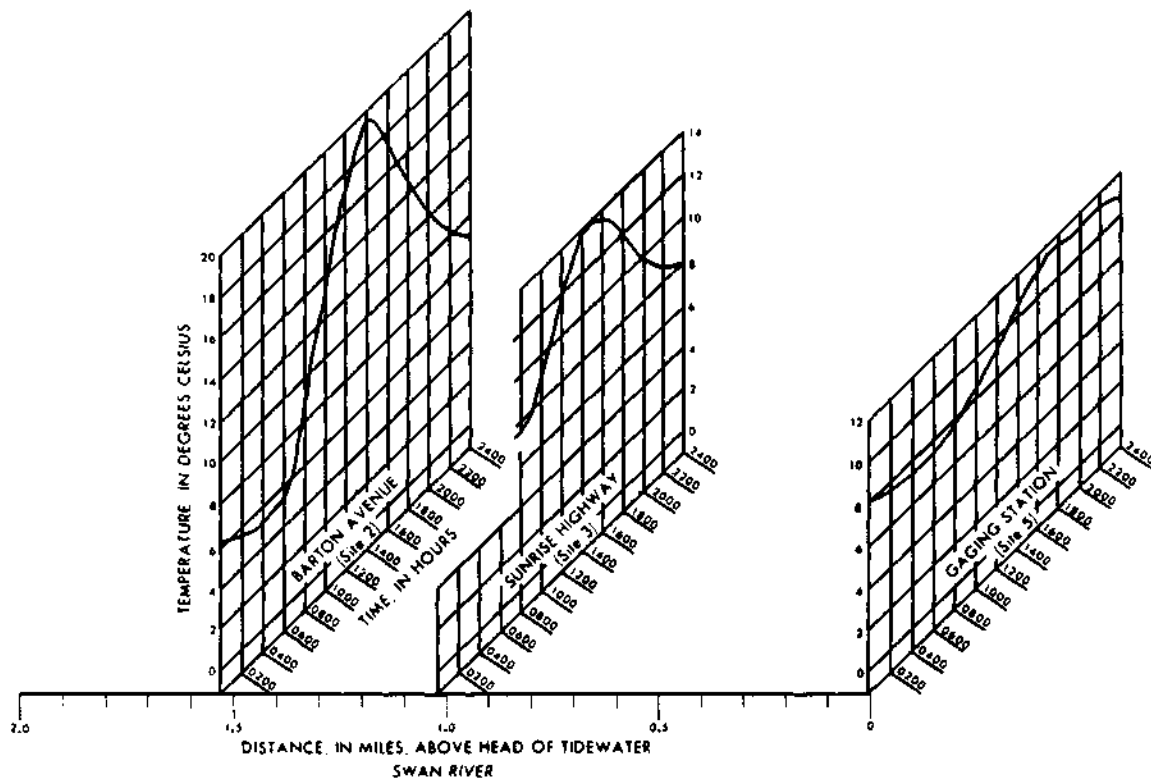

Figure 29. Temperature versus distance versus time display. Reproduced from Stevens et al. (1975).

Estimating Water Temperatures

Often one must supply estimates of water temperatures on tributaries where no water temperature data has been collected. The rule of thumb is that tributaries that change the mainstem temperature by 5% should be considered in the analysis. However, these may be either too numerous or too similar to warrant costly data collection on each one. Therefore, the typical technique used in estimating incoming temperatures is to model the tributary(s) by extending them to an arbitrarily defined "zero flow" location. That is, for model purposes, modeling the tributary from a point at which it can safely be assumed that all flow is essentially groundwater, which itself is usually assumed to be entering the stream at the mean annual air temperature. This water and subsequent accretion will be subject to the full range of meteorological effects such that, by the time it mixes with the mainstem, the predicted water temperatures should be approximately correct. Estimates so derived will become better and better the longer and more homogeneous the tributary is with respect to stream geometry conditions. Spot verifications will, of course,

Improve one's faith in this method, which is similar to that proposed by Nobel and Jackman (1980).

SPECIAL CASES

Ice Conditions

It is to be expected that temperature models such as SNTEMP will perform poorly at water temperatures near freezing. The thermal properties of liquid water alter below about 4 °C (7.2 °F). Water temperature variation is profoundly suppressed in the vicinity of freezing due to the latent heat of fusion which, in effect, means that the variation in temperature becomes more strongly influenced by the temperature of the water than by the air temperature (Song and Leung 1978). In addition, any degree of ice cover significantly affects heat flux at the water-air interface.

There are many questions one would like to ask of water temperature models in such cold conditions. For example, what is the length of open water below a controlled-release reservoir? This may be important in estimating crowding conditions for fish and waterfowl (and concomitant waterfowl disease rates) or determining ice passage conditions for terrestrial wildlife (Gosink 1986). In addition, an estimate of when ice conditions may occur could provide better stream discharge estimates because they indicate when altered stage-discharge relationships should be used (Moore 1967).

There are many research opportunities in the area of river ice related to how differing hydrodynamic and meteorologic conditions aid or hinder the formation of various rates and kinds of ice. Until more questions are answered, one may refer to an extensive bibliography compiled by Ficke and Ficke (1977), which includes sections on the freezing process, climatic effects and prediction, regulation and control, melting and breakup, ice jams, flow under ice, and ice interactions with structures. Other sources of help are the Arctic Environmental Information Data Center in Anchorage, Alaska, and the Army Corps of Engineers Cold Regions Institute in Hanover, New Hampshire.

It is clear that cold water and ice affect the mortality as well as the behavioral and microhabitat preferences of many aquatic organisms. However, studies of the effects of winter conditions in streams have been largely neglected (Needham and Jones 1959). Fish will select microhabitat sites to minimize the danger of freezing, even though it is rare that actual freezing will occur, since the freezing point of freshwater fish is usually in the range of -0.50 to -0.65 °C (31.14 to 30.87 °F) (Devries 1971).

Reservoirs

Cowx et al. (1987) observed temperatures downstream from a reservoir all year long. As expected, summer temperatures were uniformly depressed, while winter temperatures were somewhat elevated. The daily temperature variations were also dampened. The interesting thing was that the time of year when absolute maximum temperatures were reached depended more on the reservoir release schedule than on ambient meteorological conditions. In addition, their

observations and other studies they mention, lend credence to my observation that it is uncommon for a reservoir to influence temperatures more than 25-30 km downstream. Notable exceptions, however, do exist. Clearly, this will depend on the volume of release water; the larger the release, the further the effects will be felt. Cassidy and Holmes (1980) documented "significant" temperature changes 208 km (129 mi) downstream from Percy Rapids Dam on the Rogue River, Oregon.

Sylvester (1963) summarized the effects of reservoirs:

The impoundment of water will produce various temperature effects on the impounded water temperature and on the downstream water temperature, depending upon:

1. Volume of water impounded in relation to mean streamflow.
2. Surface area of impounded water.
3. Depth of impounded water.
4. Orientation with prevailing wind direction.
5. Shading afforded.
6. Elevation of impoundment.
7. Temperature of inflow water in relation to temperature of impounded water.
8. Depth of water withdrawal.
9. Downstream flow rates during critical temperature period, i.e., an increase or decrease in flow over that occurring naturally.

In general, it can be said that large and deep impoundments will decrease downstream water temperatures in the summer and increase them in the winter, if withdrawal depths are low; that shallow impoundments with large surface areas will increase downstream water temperatures in the summer; that water periodically withdrawn from the surface of a reservoir will increase downstream water temperatures; that a reduction in normal streamflow below an impoundment will cause marked temperature increases; and that 'run-of-the-river' impoundments, when the surface area has not been markedly increased over the normal river area, will produce only small increases in downstream water temperatures.

Ward (1963) employed a simple harmonic model in his investigations of the influence of reservoirs on Arkansas stream temperatures. He concluded that (1) the average annual temperature is reduced; (2) the annual variation of temperature is reduced almost by half; (3) the absolute value of the phase coefficient of the sine curve is increased. This means that minimum and maximum temperatures occur later in the year, 38 days in Arkansas; (4) the correlation index is reduced, and (5) the standard error of the estimate is increased.

Moore (1967) pointed out the similarity between spring-fed streams and impounded streams, which makes sense. Both are drawing from "reservoirs" of largely constant-temperature water. His conclusions were generally similar to Sylvester's. He did document that temperature changes occurred as much as about 90 km downstream of a newly constructed reservoir; unfortunately, the

corresponding changes in discharge were not mentioned. Speaking of springs, Webb and Walling (1988) reported substantial increases in ground-water discharge downstream from a newly constructed reservoir in England. This springflow tended to moderate the temperatures of the release water, warming the winter releases and cooling the summer releases from this largely unstratified impoundment.

Experiments I conducted (Bartholow 1985) have shown that nonstratified, run-of-the-river impoundments may actually decrease the maximum temperatures if the increase in depth is not offset by an increase in width, such as would be the case in a confined canyon area.

Many if not most applications of a stream temperature model involve reservoir construction or altered release evaluations. If it is not expected that changes in flow release patterns will themselves influence the release temperature, then the analysis is greatly simplified. However, if the flow alterations may be expected to change the release temperature, then those new release temperatures must be estimated or predicted based on some sort of a model of response. New construction can always be expected to modify the thermal regime.

As with stream temperature modeling, there are a variety of techniques that one could draw on for help. Perhaps the simplest is for the case in which a new reservoir is to be constructed, if there are similar impoundments in the region of development. Similarity may be evaluated on the basis of such parameters as elevation, depth, and fetch (the longest horizontal distance exposed to prevailing winds). Empirical equations have been developed (Shuter et al. 1983) that attempt to predict annual surface water temperature cycles during ice-free periods based on parameters such as these for stratified and nonstratified lakes. Unfortunately, I found their harmonic analysis difficult to interpret.

Other techniques relate air temperatures and surface water temperatures (Sette 1940; McCombie 1959). Different time periods are necessary for good fits. Dividing the year into two periods, one in which water temperatures are rising and one in which they are falling, improves the correlations. If enough data is available, a correlation for each month is in order. If surface temperatures are available, one could argue that they should be used directly. The correlation with air temperature, however, may be useful in frequency analysis when air temperature data is more readily available. In any case, these calibrations require that data be available for representative reservoirs, usually nearby.

The literature contains examples of methods to control temperatures downstream from reservoirs without a multilevel release facility by varying gross release schedules for different seasons of the year (Wunderlich and Shiao 1984). This method utilizes a "cold water index," which is the ratio of the sum of reservoir releases within a planning period to the cold water volume in the reservoir at the start of the period. The index is reservoir specific and can be used in operational-constraint type models when multiple objectives, such as power generation and flood control, are involved.

An additional level of difficulty is introduced if the proposed or actual withdrawal is of the multilevel design such that water may be removed from one or more vertical tiers within the reservoir. Such a multilevel design may be used to help control a variety of water quality attributes including temperature, dissolved oxygen, and turbidity. Though the difficulty of "predicting" release temperatures is increased in such a situation, the flexibility of meeting temperature release targets for a specified time is markedly increased. Exact targets should not be expected; instead, target "windows" provide the needed water management flexibility (Cassidy and Holmes 1980). Sine curve correlation may be a potentially useful technique for predicting water temperatures at different depths in a reservoir (Kothandaraman and Evans 1970), but care must be used if alternative water management scenarios are likely to change these profiles very much. It is apparently rare for geographic stratification patterns to recur on a yearly basis (Wunderlich and Elder 1967).

In reservoirs with multilevel outlets, the temperature of the outflow is highly dependent on inflow hydrodynamics. In addition, the actual water strata withdrawn is not as simple as might be expected. Water is "sucked-in" based on the velocity, the relative density differential of the water layers, and the size of the intake structure. The higher the velocity, the more likely it is that water layers above the intake get entrained. Consultation with an experienced hydrologist-engineer is highly recommended.

In addition to the thermal release characteristics of reservoirs, there are a variety of water quality concerns, both during the initial filling (Gunnison et al. 1986) and operation (Terrell et al. 1982), that are beyond the scope of this paper. However, because reservoir release temperatures are so often integrally related to the modeling of downstream temperatures, we will list a variety of models available for performing predictive analysis (largely taken from ERA 1984, and Corps of Engineers 1987). No attempt will be made to evaluate these models here.

1. Water Analysis Simulation Program (WASP) - A one- or three-dimensional general reservoir water quality, including temperature, model for planktonic analysis. Model is public domain with user's manual and technical assistance available from EPA's Large Lakes Research Station in Grosse Isle, Michigan.
2. CLEAN Series - General reservoir modeling package for well-mixed to stratified conditions in reservoirs, fish ponds, and alpine lakes. Model is public domain with user's manual and technical assistance available from EPA's Environmental Research Laboratory in Athens, Georgia.
3. LAKECO - A one-dimensional model for calculating temperature, dissolved oxygen, and nutrient profiles for wasteload allocation. Model is public domain with user's manual and technical assistance available from the Corps of Engineers Hydrologic Engineering Center in Davis, California.
4. Water Quality for River Reservoir Systems (WQRRS) - Similar to LAKECO, but can also consider river flow and quality. Model is

public domain with user's manual and technical assistance from the Corps of Engineers Hydrologic Engineering Center in Davis, California.

5. CE-QUAL-R1 - An extensive one-dimensional model of reservoir water quality, descended from WQRRS. This model is reported to work well in fluctuating-level reservoirs. Model is public domain with user's manual and technical assistance from the Corps of Engineers Waterways Experiment Station in Vicksburg, Mississippi.
6. CE-QUAL-W2 - A two-dimensional reservoir (and other waterbody) water quality model similar to CE-QUAL-R1. Model is public domain with user's manual and technical assistance from the Corps of Engineers Waterways Experiment Station in Vicksburg, Mississippi.
7. CE-THERM-1 - A one-dimensional reservoir model exclusively for predicting temperatures as controlled from multilevel outlets. This model is also reported to work well in fluctuating-level reservoirs. Model is public domain with user's manual and technical assistance from the Corps of Engineers Waterways Experiment Station in Vicksburg, Mississippi.
8. WESTEX - A one-dimensional reservoir model for temperature and conservative constituent modeling for optimal design of multilevel outlets. Model is public domain with draft user's manual and technical assistance from the Corps of Engineers Waterways Experiment Station in Vicksburg, Mississippi.
9. SELECT - A one-dimensional, steady-state, selective-withdrawal model for deciding which ports to use to meet downstream water quality objectives. Model is public domain with draft user's manual and technical assistance from the Corps of Engineers Waterways Experiment Station in Vicksburg, Mississippi.
10. HEC-5Q - Reservoir system simulation/optimization model for water supply and water quality planning studies. Model is public domain with user's manual and technical assistance available from the Corps of Engineers Hydrologic Engineering Center in Davis, California.
11. Laterally Averaged Reservoir Model (LARM) - LARM is a one- or two-dimensional temperature and reservoir flow model useful in reservoir/stream networking analysis. It has been used in estimating release temperatures over time of varying the release outlet location (Gordon 1981), and it has been used in conjunction with SNTMP on complex stream networks in California (Lifton et al. 1985). The two-dimensional model requires 15-minute time steps to remain stable. The model is in the public domain and available from the Corps of Engineers Hydrologic Engineering Center in Davis, California.

Microthermal Habitats

All of the water temperature models we have employed are one-dimensional models in that they assume that the water is thoroughly mixed at any point in time and space, and therefore can be used to predict temperature patterns longitudinally (downstream) only. They contain no facility for looking at temperature changes horizontally (across the channel) or vertically (from top to bottom). At moderate to high flows, this assumption should not be a major difficulty. But at low flows, when most temperature extremes are reached, you need to examine this assumption more closely.

Bilby (1984) classified four distinct types of cool-water areas in a fifth-order Washington stream (Table 10). He termed them lateral seeps, pool bottom seeps, cold tributary mouths, and flow through the streambed. Temperatures in these cool-water areas averaged 4.7 °C (8.5 °F) lower than ambient water conditions on warm afternoons. A total of 39 cool areas were found within a 3.5 km reach, and collectively accounted for 1.6% of the surface area and 2.9% of the water volume of this stream.

Table 10. Average size, depth, and temperature depression of the cool-water areas found by Bilby (1984) in a Washington stream (discharge not reported).

	Average size (m ²)	Average depth (cm)	Average temperature depression (°C)
Lateral seeps	1.3	15	4.7
Tributary mouths	6.0	23	5.3
Pool - bottom seeps	7.3	43	4.9
Undergravel flow	4.6	38	3.9

The areal extent of cool-water areas formed by lateral seeps and tributary mouths was influenced by the characteristics of the stream channel upstream from the point of cool-water entry. Anything that served to deflect warm, flowing water from mixing with the cool water formed protected cool-water areas (Figure 30).

In general, the seeps had a greater degree of thermal constancy and a greater temperature depression than did the undergravel flow areas, which represented the majority of the cool-water area. This was attributed to seepage being actual ground-water effluent, whereas undergravel flow had originated as instream water and was only cooled by its passage through the streambed. The undergravel flow therefore showed some diurnal temperature variation.

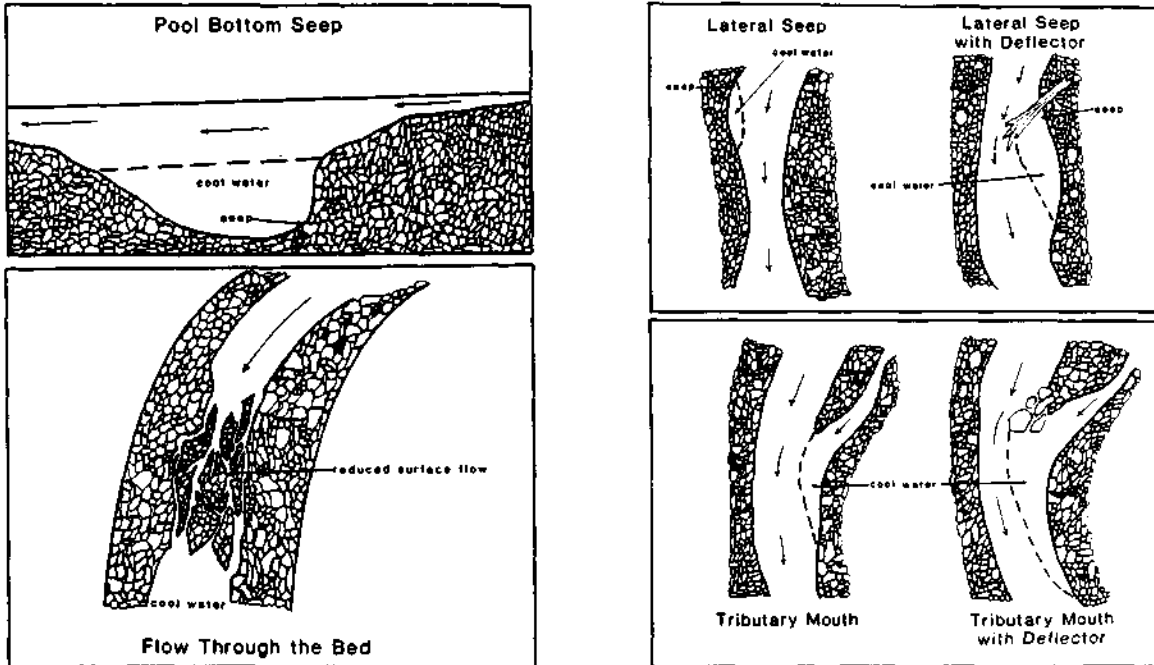

Figure 30. Common areas in which to expect temperature-created microhabitat. Reproduced from Bilby (1984).

In similar work, Ozaki (1988) surveyed 21 km of Redwood Creek, northern California, for cool pools. These pools, defined as areas that maintain water temperatures more than 3 °C (5.4 °F) lower than adjacent water, represented less than 9% of the total pool population. All of these pools were at least partially segregated from the low-flow channel by gravel bars and were maintained at depressed temperatures by either hillslope groundwater, tributary inflow, or intergravel flow, with the latter two being most important. The temperatures recorded were independent of the pool's depth or volume, and thus felt to be dependent on inflow quantity and temperature. Pool width-to-depth ratio seemed to be related to the pool-mainstem temperature differential: the longer and narrower the pool, the cooler the pool. Most pools exhibited some form of stratification in the sense that the deeper parts were colder. However, most pools were not stratified in the sense that they exhibited a distinct thermo-cline.

Bilby's and Ozaki's findings may be contrasted with those of Neel (1951) who found ample evidence of true thermal stratification in the small, headwater streams of Kentucky. Though some pools were found to be spring-fed, others showed decided stratification (up to 6 °F, 3.3 °C) at low flows. The stratification Neel found was not the stratification of stagnation, but rather that of segregation of thermally distinct flowing water. That is, at different times,

one might find warmer water flowing across the top of the pool, or cooler water flowing along the bottom (or even at intermediate depths).

Neel found that water surface elevations in riffles were fairly reliable indicators of thermal stratification in downstream pools, even very shallow ones. If the water surface elevation fell (slowly) below a specified level, thermal stratification would be found. However, this was not true if water levels were fluctuating frequently. These fluctuations would combat the formation of thermal layers. This principle is nicely shown in Figure 31, which depicts the maximum water temperature as a function of depth and flow for the Eel River. For example, an 8 cfs flow creates a thermocline at a depth of 4-5 feet. Increasing the flow to 44 cfs lowers the thermocline to 10-12 feet. At 83 cfs there is no thermal stratification. This figure also illustrates that stratification maintains a marginal habitat even on very hot days. Thus, under conditions of very limited water supply, it may be preferable to actually reduce flows in order to protect cool-water refuges, such as these California pools used by juvenile anadromous fish. At a minimum, care should be taken not to increase flows in the afternoon, thus disturbing the thermally segregated water.

Anderson and Miyajima (1975) found that they could lower stream temperatures in constructed pools by 1 to 4 °F (0.6 to 2.2 °C), and that peak temperature (over 72 °F, 22.2 °C) duration could be shortened from 12 hours in riffles above the pools to 1-2 hours in the pools (Figure 32).

Cool-water refuges in or near tributary mouths present more of a problem. We know that thermal segregation occurs some distance downstream from tributaries (or other point sources) even though the models assume instantaneous and thorough mixing. At times it may be desirable to estimate this longitudinal mixing distance. One approximation for rivers and streams in which the depth is less than one tenth of the width is (Milhous, pers. comm., adapted from Ruthven 1971):

$$L = \frac{0.085 W^2}{D^{5/6} * n}$$

where L = mixing length (feet) that assures the variation in temperature across a section arising from a point source interjection does not exceed 10%

W = average stream width (feet)

D = average stream depth (feet)

n = average Manning's n (roughness)

For example, suppose you had a river 100 feet wide, 5 feet deep, with an n value of 0.06. The length to near complete mixing would be:

$$L = \frac{0.085 \cdot 100^2}{5^{5/6} * 0.06} = \frac{850}{3.82 * 0.06} = 3705 \text{ feet}$$

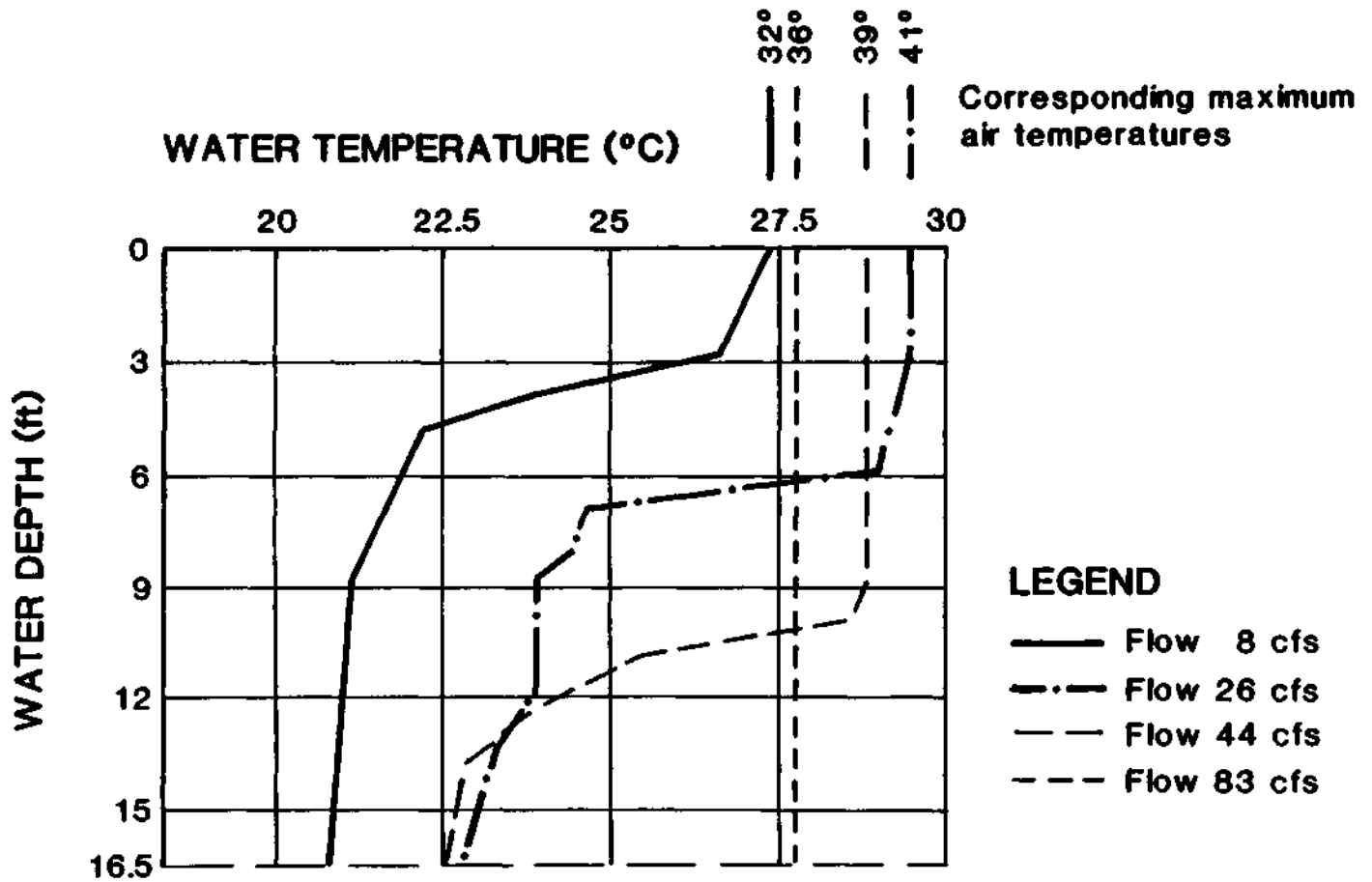

Figure 31. Temperature profiles within a pool at various flows. Illustrates the elimination of stratification at higher flows. Adapted from California Department of Water Resources (1976).

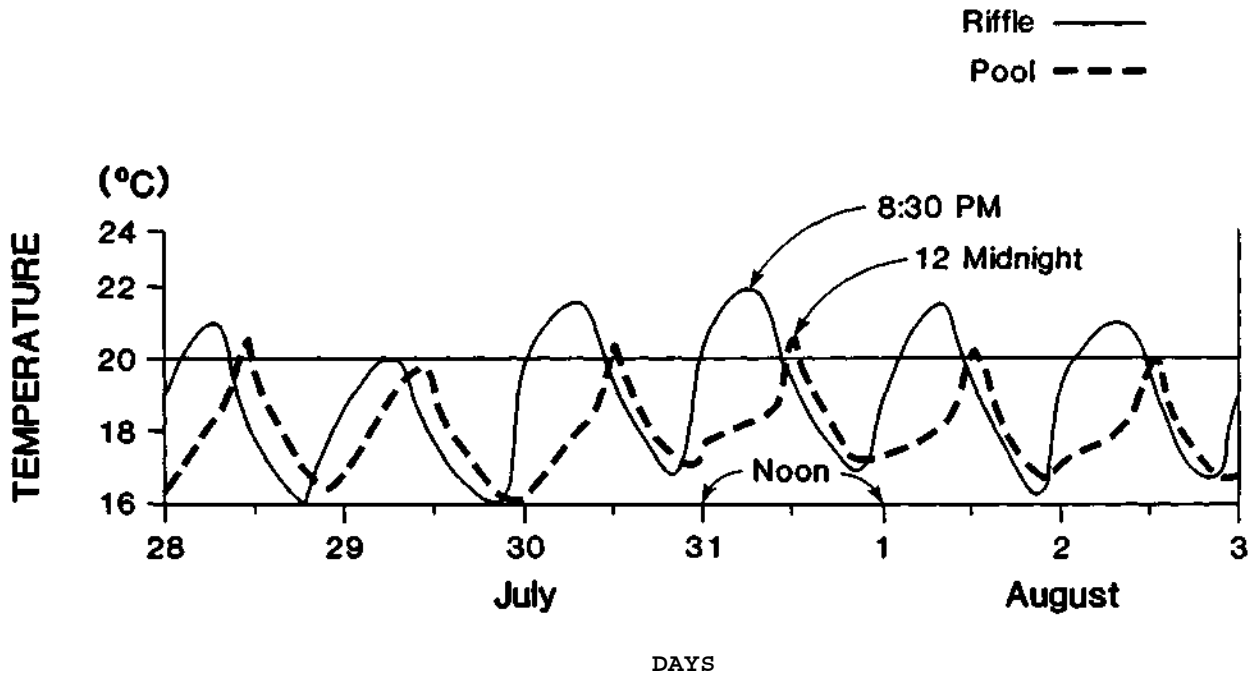

Figure 32. Comparison of water temperatures in pools and upstream riffles. The volume of pools buffers water temperature in low-flow situations. Adapted from Anderson and Miyajima (1975).

It is very important to remember that the roughness value is a function of flow and can increase dramatically at low flows. Also, any channel bends or other features will tend to shorten the mixing length. Consult an experienced hydrologist when applying this formula.

An alternative method of estimating the length of channel, from a side channel, necessary for complete mixing may be found in Hubbard et al. (1981). It does not involve the use of Manning's n , and has been adapted as shown here:

$$L = \frac{0.062 v * w^2}{d^2 * s}$$

where v = velocity (ft/sec)

w = width (ft)

d = depth (ft)

s = slope of water surface (ft/ft)

From simple experimental calculations, it would appear that this formula is very conservative in its estimation for truly complete mixing by overestimating the distance in small streams. For example, using the same situation as above with an average velocity of 3 ft per second and a 1% gradient:

$$L = \frac{(0.062) (3) (100^2)}{(5^2) (.01)} = 7,440 \text{ feet}$$

One might hope that a reasonable answer may be bounded by these two calculation methods. As always, there is no substitute for field verification.

Not only do stratifications, seepage, and thermally segregated waters produce measurable temperature differences, but also it is well documented that fish take advantage of them. Gibson (1979) used skin diving techniques to observe salmon parr moving into a spring seepage of 17 °C (62.6 °F) when the main river temperature rose above 22 °C (71.6 °F). They were physically oriented towards the source of the cool water and showed no apparent territorial behavior. Kaya et al. (1971) documented trout moving into the mouth of cool-water streams in a geothermally active area of Yellowstone Park.

Though the focus of the above studies has been towards the areas of cool water during times of otherwise high temperatures, the other end of the spectrum needs to be examined as well. During the winter, ground-water effluent, undergravel flow, tributary mouths, and other locally heated areas can offer respite from very cold water with similarly documented concentrations of fish (Kaya et al. 1971; Coutant et al. 1984).

It is unlikely that cost-effective models that can predict thermal microhabitats will be available for some time. About the best that can be done is to take spot temperature measurements at low flow to see if stratification, ground-water seepage, or undergravel flows do occur and to what extent. You need to be aware that such areas exist and that mobile aquatic organisms do seek refuge in times of thermal stress, both when ambient waters become too hot or too cold. It would be nice to determine the spatial and temporal uses of aquatic species in differing thermal microhabitats in the field. I am aware of temperature sensitive ultrasonic fish tags (Rochelle and Coutant 1973), but unaware of specific results of using such tags.

The most effective and accurate way to make microthermal measurements is with a thermistor probe. Bare-legged wading may show where these areas are located; then use the probe to make very localized and undisturbing temperature measurements. If such a probe is not available, a complete immersion thermometer should be used, with the instrument turned horizontally such that its entire length is exposed to a constant temperature (Neel 1951).

Though these microhabitats do exist, and offer the best refuge in times of temperature extremes, don't rely on their existence. Existing field data suggest that they are too thinly spread (Bilby's 1.9% of total stream area and Ozaki's 9% of all pools) to support a true fishery, though they may offer hope for repopulation after extreme events.

SIMULATION AND ANALYSIS TECHNIQUES

ALTERNATIVE PREDICTIVE TECHNIQUES

In any given study, there may be reasons to choose among alternative temperature models due to the objectives of the investigation as well as the constraints involved. Among those alternatives are (1) monitor temperature response to a range of flow and meteorological conditions, (2) use regression-type models, (3) use process-oriented models, or (4) use some combination of the above.

Measurement Only

It is always worth mentioning that certain temperature management problems may lend themselves to measurement only. Existing data may be sufficient in the simplest cases to demonstrate that there is or is not a temperature problem. In more complicated cases for which the opportunity to experiment exists (alternative flows for example), reliable temperature estimations may be obtained from interpolation or limited extrapolation. Thus, explicitly avoiding formal modeling is always an alternative. If sufficient flexibility exists in water management that flows may be manipulated through the range of feasible alternatives, and the variability in meteorological conditions is expected to be fully realized, a carefully executed temperature monitoring study should be possible. (Note that a special case may be represented by relying on existing historical water temperature data.) The system's response could then be carefully interpolated from the measured data.

The dangers of such an approach, however, should be apparent in the above wording. This assumes that it is only flow, or possibly reservoir release temperature also, that are the management alternatives. Care should be taken to not overly constrain the range of alternatives evaluated. Though it may be reasonable to extrapolate above the range of measured flows, it would not be wise to extrapolate below that range because the rate at which water approaches equilibrium is highly nonlinear at low flows. It is not often that the full range of meteorological conditions can be expected to occur. An analysis of the recurrence interval of daily maximum air temperatures, for example, may illustrate the expectancy of such conditions. Because these opportunities are felt to be limited, because changes in shade or stream geometry cannot be easily manipulated, and because the range of meteorological conditions may be incomplete, other techniques will often need to be employed.

Regression Models

Regression-type models are very attractive in their simplicity and understandability. Data requirements are often minimal, and the relative sensitivity of parameters can be easily derived. Do not, however, fall prey to reducing the number of terms to just water temperature and flow. Always examine other terms (see below). The models as outlined by Theurer (1984) are far more

robust. The "zero lateral flow heat transport" regression model is theoretically the best model because its parameters have been "transformed" to the mathematical form used in the process-oriented simulation models, but some experience has shown that the variance reduction in the estimates may not be worth the trouble. It is especially prone to problems if the geographic location of interest is below a reservoir or a "major" tributary that represents a thermal discontinuity. The simple multiple linear regression may be a reasonable alternative. Its first-order form is:

$$T_w = a_0 + a_1 T_a + a_2 W_a + a_3 R_h + a_4 (S/S_0) + a_5 H_{sx} + a_6 Q$$

where T_w = temperature of the water

T_a = temperature of the air

W_a = wind speed

R_h = relative humidity

S/S_0 = percent possible sun

H_{sx} = solar radiation

Q = discharge

The units may be any you choose, and the predicted temperatures may be minimum, mean, or maximum. Second-order terms may be added if the data set is large enough. Please consult a statistician for appropriate sample sizes and determination of which parameters to retain in an analysis. Always examine the standard error for each coefficient to see which terms to include in your model and which to throw out. Beyond the simple linear regression above, ingenuity may be in order. For example, one application determined that the difference in maximum temperature from predicted mean daily temperature was best estimated by a regression of the form (Wim Kimmer, pers. comm.):

$$\Delta T = a + b * \ln(Q)$$

where ΔT = max daily temperature - mean daily temperature

a and b = empirically derived coefficients

Q = mean daily discharge

\ln = natural log

Some support for this formulation may be found by remembering the form of the relationship between width and flow as well as between n and flow.

The SNTMP model has a limited ability to fill in missing discharge measurements based on an average of known values from the same time periods. It has a much more sophisticated set of regression techniques for missing water temperature values. In addition, water temperature values may be "smoothed" to

handle outliers that may have resulted from grab-sample data collection methods, lack of quality control, or malfunctioning equipment. As with any regression approaches, there cannot be any change to the system. If a reservoir has been constructed during the period of record used to fill or smooth data, for example, two regressions would need to be developed, one to describe the predam conditions and one for the postdam conditions.

There are also other methods for estimating missing water temperature values. One promising methodology is the use of "harmonic" analysis. Though there are several variations on this theme, they all work by fitting one or more sine waves to the known data. One technique that shows promise for predicting daily water temperatures from temperatures taken on a less than daily time step (periodic or irregular) is contained in a paper by Gilroy and Steele (1972); also see Ward (1963). The method used need not be constrained to any particular time step. The basic form of the sine wave relationship is:

$$T_j = M + A \sin(bj + C) + e_j$$

where T_j = the stream temperature on Julian day j ($^{\circ}\text{C}$)

M = the overall mean temperature for the time period of interest ($^{\circ}\text{C}$)

A = the amplitude of the sine wave ($^{\circ}\text{C}$)

C = the phase angle (degrees)

b = the fundamental period of the sine wave; equal to $(2 \pi)/365$ (or 336)

e_j = the random error term ($^{\circ}\text{C}$)

You may use this relationship and determine the best fit coefficients M , A , and C through standard least squares (or other) regression analysis. To do so, however, the formulation must be changed to:

$$T_j = M + A_1 \sin(bj) + A_2 \cos(bj)$$

where the parameters from above are then:

$$C = \arctan(A_2/A_1)$$

$$A = A_1/\cos(C)$$

For simplicity, however, just leave the equation in the second form containing both the sin and cos functions.

It may often be profitable to use these formulations in conjunction with one another. For example, it is usually easy to obtain at least air temperature data near the stream of interest; flow data must be obtained or estimated. All other meteorological data may then be lumped, in effect, into the sine wave equation. Thus, the formulation would become:

$$T_j = A_0 + A_1 T_{a_j} + A_2 \ln(Q_j) + A_3 \sin(bj) + A_4 \cos(bj)$$

which is very easy to deal with and generally produces good (R-squared values >0.85; standard error <1.5 °C) correlations. This still requires scrutiny. Continue to make sure which terms should or should not be in the equation. Narrowing the time frame to times of rising or falling water temperatures will always help. This formulation will almost always underpredict water temperatures in the winter, and should, at a minimum, be constrained to predict positive numbers.

It may be tempting to use one of these regression techniques in place of more process-oriented models. But it is imperative to remember that models based on regression have major limitations, due to their underlying assumptions--they are valid only as long as the surrounding conditions do not change. As with the direct observation method, regression models do not lend themselves to extrapolation outside of the range of hydrologic, meteorologic, or stream geometry conditions measured. Nor may they be translated geographically upstream, downstream, or to other drainage basins without great care. Theurer (1984) makes excellent use of the regression models to fill in the inevitable missing temperature data in large network analyses, but he applies a separate regression to each specific geographic location. Properly developed process-oriented models largely overcome these limitations.

I and others also feel that measures of standard error obtained from regression analysis models are more understated than for the process-oriented models, due to the substantial autocorrelation in both the observed and predicted water temperatures (Millard et al. 1985). Hirtzel et al. (1982) developed methods to better account for this high autocorrelation, but the techniques are perhaps too sophisticated to use on a regular basis.

Please see the section on statistical models for more on this subject and results other modelers have had.

Segment Models

The class of programs known as the segment models are abbreviated versions of the more complete SNTEMP programs. Currently, there are three programs making up the segment family: SSTEMP for temperature modeling, SSSHADE for shade estimation, and SSSOLAR for solar radiation estimation. This class of programs has proven valuable for handling one to a few stream reaches in a simple configuration for a limited number of time periods, and for sensitivity analysis.

The stream segment models (Theurer 1984; Bartholow 1988a,b,c) are quite useful for simplified modeling and sensitivity analysis. Data input parameters may range from "back of the envelope" type calculations to detailed micrometeorological field measurements, with corresponding degrees of reliability. However, their use becomes tedious and error prone as the number of stream segments or time periods increases. Nonetheless, these segment models may be used for a high percentage of temperature modeling applications.

Network Models

The SNTEMP model, though initially more complicated than the segment models, will quickly negate that complication when you are dealing with over

five stream segments or 30 time periods or scenarios. Automated data filling and smoothing, coupled with post-simulation statistical evaluation, makes this truly a high-powered approach. Additional linkages to microhabitat models (Bartholow and Waddle 1986) add to its flexibility. It is primarily to the network model that the following sections are devoted.

CALIBRATION/VALIDATION

It is worthwhile to review some basic concepts related to the testing and usefulness of all modeling efforts, including temperature modeling. There are several terms, often used indiscriminately, that variously purport to describe the process of ensuring that a simulation model "works," be it purely statistical, purely process-oriented, or (most likely) a combination of the two. There are both quantitative as well as qualitative measures for determining the overall usefulness of a model.

It is not my purpose to debate the many definitions that have been used for these terms in the past, but rather to supply operational definitions useful to describe the overall processes involved, so that we will know when we have a useful model. See the published guidelines by the General Accounting Office (1979) for more in depth discussion of validation definitions. What we are after is the answers to operational questions: How good are these models? How well do they represent natural systems? Can they be used for management and regulatory decisionmaking? What level of confidence can we place on the results? (Donigian 1983). (Also see an interesting paper by Hankin et al. [1975].)

The terms used will be better understood in the context of the scientific method. This begins with a concise statement of the problem and study objectives. These are intimately tied to the decisions that need to be made. Next, the problem is analyzed in a process consisting of observation, measurement, sampling, and experimentation. Solution methods are examined, with the choice of techniques made from a set of criteria. The solution is evaluated with respect to reliability and sensitivity. If successful, the results or decisions are implemented (Reckhow and Chapra 1983).

"Calibration," for our purposes, is defined as the process of determining "proper" values for an existing model's parameters. Note that I said "existing" model because I do not, at least initially, want to cover model development. If the structure and function of a model have been shown to be satisfactory for some types of problems in the past, we may only be faced with choosing "proper" rates for describing how much one thing changes with respect to something else, or supplying a measurement or estimate for other environmental values. Calibration should always constrain the values of parameters to be within "reasonable" limits. If one must deviate from the reasonable, one will be forced to retreat to reformulation of the model.

"Verification" is used to describe the testing that is done as part of the calibration process. Verification is the process of testing the model's output (spatial and/or temporal patterns) against "real world" measurements, looking for congruence, or the "best fit," with what we have previously observed. If we cannot supply parameters that produce output that is congruent with the

observed situation, then we must assume the model is to some degree (theoretically) inconsistent with the real world and hence retreat to the process of model formulation. This implies that we have a dynamic understanding of the system being modeled and that we are really in an experimental process (Lee 1973). Again, I will not deal with this issue; refer to an excellent description of the model-building process called "invalidation" by Hoiling et al. (1978), which is approached as finding the (confidence) limits of model credibility, both under normal and extreme conditions.

There are several criteria that may constitute the verification process. These criteria are not fixed and rigidly defined, but rather depend on the objectives of the study. Accuracy is always the first criterion that comes to mind. Undoubtedly, one's trust in the application of a model will increase if the model is capable of faithfully reproducing the current or historical situation. I will also discuss certain statistical measures of goodness-of-fit. Calibration/verification may also serve in determining the model's overall sensitivity to changes in parameter values and may suggest additional data collection to replace estimated parameters with measured ones.

The term "validation" will for the moment be narrowly constrained to describe the quantitative measures of goodness-of-fit between a parameterized model's output and the observed system. There are two primary ways in which this may be done (Reckhow and Chapra 1983). The first is most useful in validating process-oriented simulation models; one may calibrate a model for a subset of the data, carry the parameters thus determined to the other data subset and test the unadjusted model's performance using goodness-of-fit criteria (Figure 33). For example, you could calibrate a model based on the year 1985, then test its performance for the years 1986 and 1987.³ The second method is similar and most useful in regression-type models. In this method, one may divide the entire data set into two relatively equal parts, each with the full complement of variation. Both sets are then independently calibrated. Parameters determined for the first data set may be compared to parameters derived from the second data set using goodness-of-fit criteria. If not significantly different, the models are confirmed (validated). Care needs to be exercised here such that the two data sets are not really the same due to high autocorrelation. You would not want to divide a daily time-step model into every-other-day sets, whereas every-other-week would probably work out well. Each day is usually highly correlated with the day before, whereas each week is less likely to be correlated with the week before.⁴ In fact, the more different

³Typically, the subset of the data used for calibration purposes has been a subset in time; however, the possibility exists that a spatial subset may also be employed in the sense of using a parameterized temperature model from one watershed to neighboring watersheds.

⁴It has been shown that the maximum weekly average temperature, computed from running 7-day averages, can be closely approximated by a pure weekly time step within 1.4 °C (Ferraro et al. 1978). How general these results are, I don't know.

Full "Split Set" Calibration/Validation Scheme

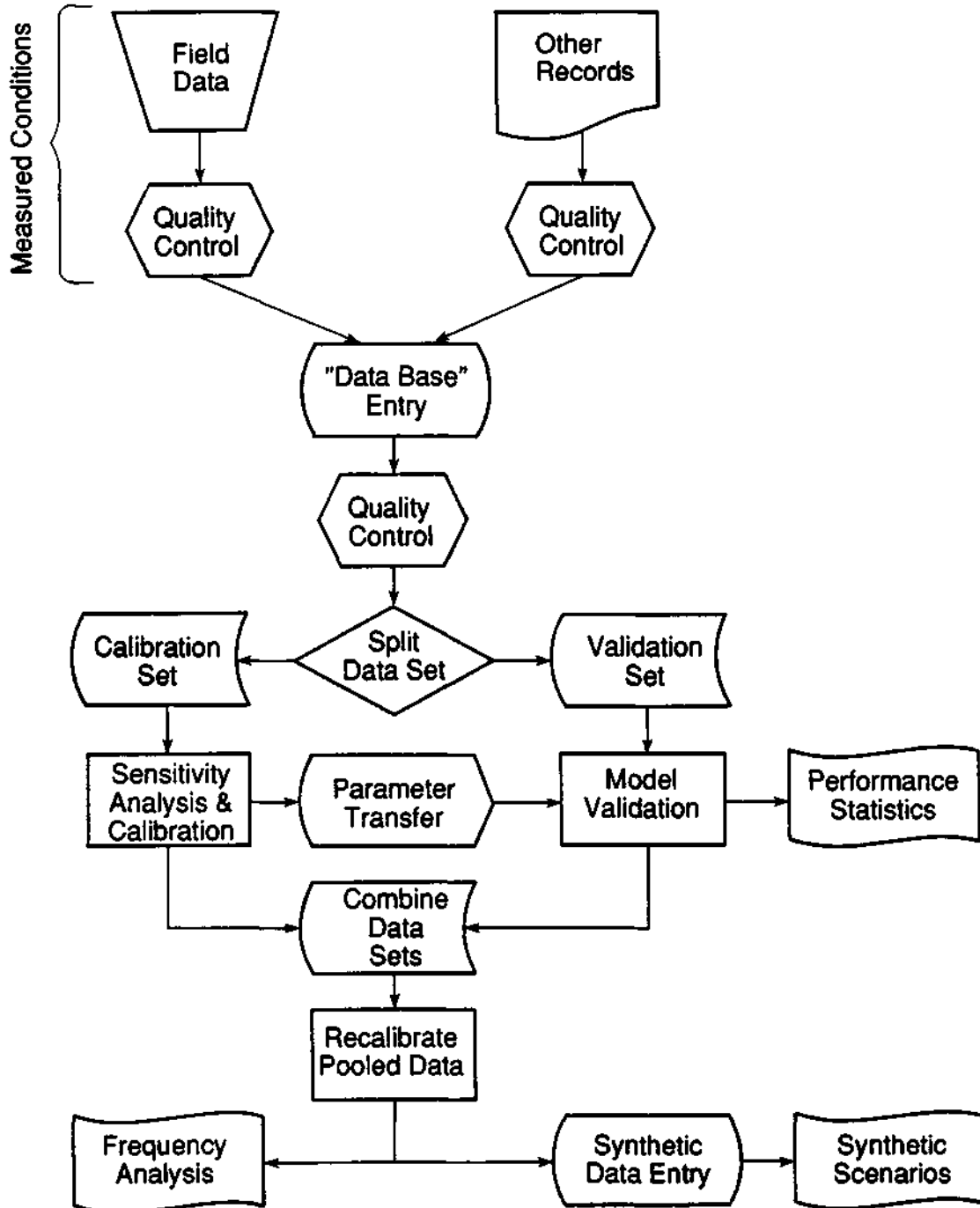

Figure 33. Full "split set" calibration/validation scheme. Adapted from Ken Voos (pers. comm.).

the two sets of data are, and the greater the variety of conditions from one to the other, the more confidence the modeler should have in the predictive capability of the model. In either case, upon successful confirmation, the data subsets should be recombined and the parameters re-estimated so that all of the data can be used in the final calibration process. However, I would stress that neither of these calibration/validation methods must be used all the time; the need, or lack thereof, is directly related to the objectives of your study. If models of this type have been successfully validated in similar settings, you may limit yourself to calibration and verification only.

When faced with "new" data, previously calibrated models may exhibit strange behavior. You may be asking the model to operate outside the "domain" of its calibrated parameters. This is especially true for purely statistical models, and becomes even less true for the very best process oriented models. As used here, therefore, validation may be considered a component of the basic scientific method, in which hypotheses are tested and either accepted or rejected on the basis of predetermined, statistically rigorous, criteria (Sanders 1985). It is worth mentioning that if the model (hypothesis) is not rejected, it is not truly "valid," but rather it is "confirmed" or "corroborated" in the sense that the hypothesis is compatible with the current evidence. No model is "valid" because no model is completely "true" (Reckhow and Chapra 1983).

When properly validated, a model may be expected to adequately predict future outcome from a set of specified input data *if* we can reasonably expect the model's parameters to exhibit a degree of constancy over a broad range of space and time. It is important that we critically examine this aspect of modeling. A concrete example might involve a proposed change in a hydrologic regime. Will this change lead to subsequent changes in stream width and riparian vegetation? Will altering the riparian vegetation change the temperature of the groundwater? Will constructing a reservoir increase the ground-water inflow downstream? If so, will a specific model, or modeling process, handle that change?

All of the, above definitions are actually preceded by an umbrella of overall model validation to be determined *before* a model application. This definition gets more at the qualitative issues of whether the model is appropriate for the task at hand and whether it will successfully help us make more accurate, timely, and ultimately useful decisions. "Appropriateness" refers to such things as the availability of estimates for model variables, data collection needs and costs, whether the model is accepted academically or institutionally, whether the model is compatible with other models that must be used (e.g., habitat models and reservoir release temperature models), what the limiting assumptions are, and whether the model's output is truly relevant to the problems at hand (Bartholow 1976; Ambrose et al. 1981).

Goodness-of-fit criteria for temperature modeling may take several forms. Some measure, such as root mean square error, should be employed as the primary statistical index (Chapra and Reckhow 1983):

$$RMSE = \left[\frac{\sum (P_i - O_i)^2}{n} \right]^{0.5}$$

where P_i = prediction at time/space i

O_i = observed value at time/space i

n = number of samples

This measure should be specifically directed toward the predictive values of importance: mean values, variability, or extreme values. It would be inappropriate to test a model's performance for predicting mean values if the maximum values were the true performance measure. Examples of validation criteria that have been used after a calibration to a mean bias error of 0 °C are:

1. No more than 10% of the simulated temperatures are greater than 1 °C from measured temperatures.
2. No single simulated temperature is greater than 1.5 °C from measured temperatures.
3. The mean of the absolute values of the observed minus predicted values is less than 0.5 °C.
4. There is no trend in spatial, temporal, or "temperature" error.

This last criterion needs further explanation. Since, in the case of SNTEMP, we are dealing with the prediction of stream temperatures through both space and time, we are using a multidimensional model in a statistical sense. We may be able to identify errors (prediction minus observation) in any dimension. Perhaps the best way to do this is to (1) plot error at single or aggregate times from upstream to downstream, (2) plot error at single or aggregate locations through a time series, (3) plot error against observed water temperatures, or (4) plot error against input variables. If trends are present, it is evidence of some systematic error. In statistical terms, we are looking for homoscedastic residuals (Reckhow et al. 1986) (Figure 34).

Making error plots will serve not only to highlight "outlier" data points, but also to provide information on the general shape of the distribution. A "point cloud" will indicate no trend (Figures 34b,e). A sloping band may indicate that there is a linear bias in your model. A curved band indicates a more fundamental, nonlinear, problem. Finally, a wedge-shaped distribution indicates a systematic error that increases or decreases with the value on the x-axis (Goodall 1983).

There are various other statistical techniques that have been advocated to establish a goodness-of-fit relationship. As previously mentioned, the most common method is regression analysis between the observed data and the simulation values, testing the hypothesis of a zero intercept and a unit slope. This is essentially the technique employed by Theurer et al. (1984). The principal drawback of this approach seems to be that it does not determine that the variance of the two data sets is less than some tolerable limit (Ringuest 1986).

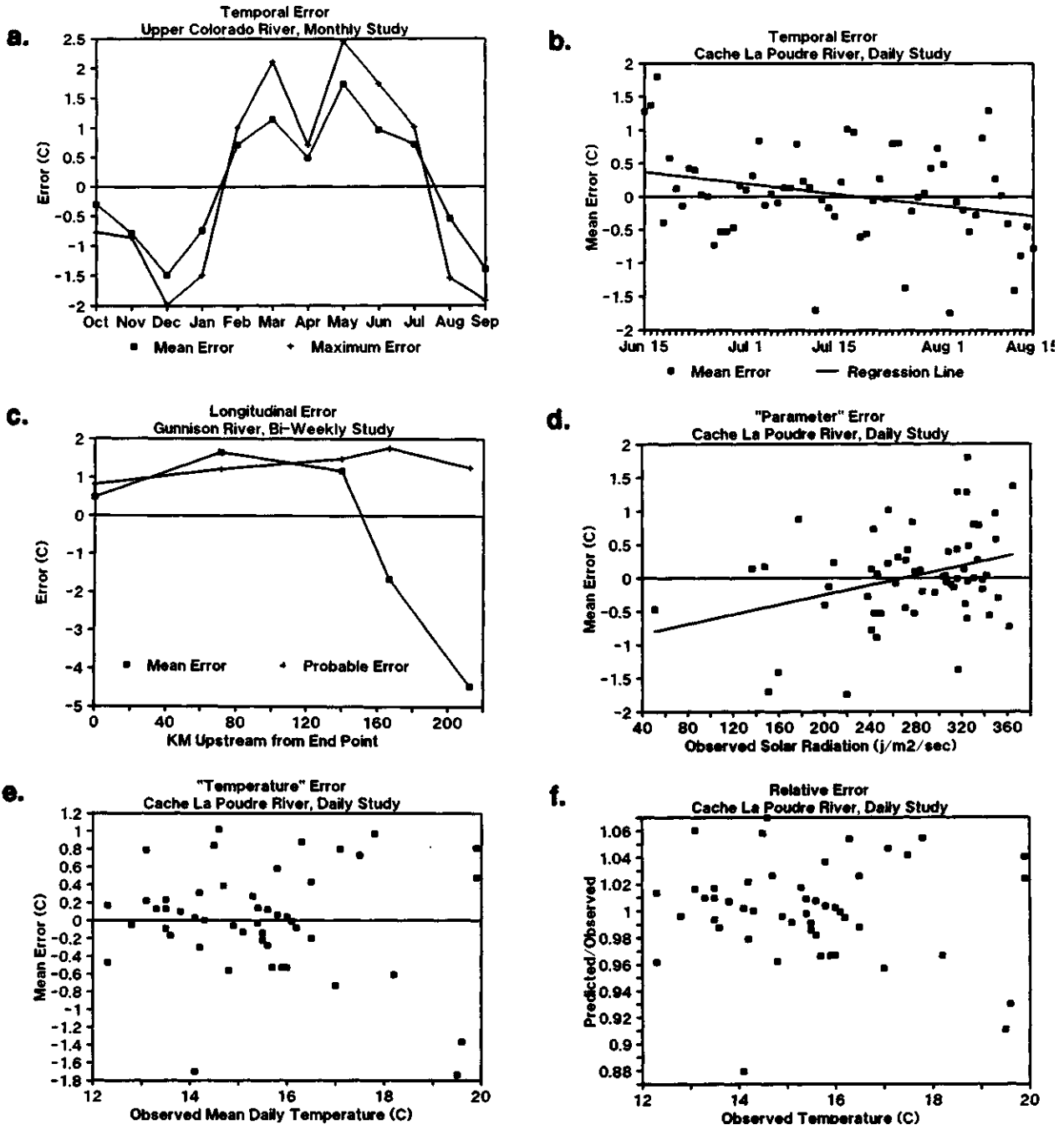

Figure 34. A spectrum of perspectives on possible causes of model error. (A) Temporal error showing nonrandom bias with month of the year. (B) Lack of overall temporal error in a daily simulation. Regression indicates a mild, but insignificant trend. However, there is a hint of a periodic (perhaps weekly) trend. (C) Longitudinal error showing an increase in the model's bias in an upstream direction. (D) Parameter-by-parameter error. In this case, the model's bias was weakly ($R^2 = 0.1$) associated with solar radiation. (E) "Temperature" error plot to determine if the model's bias is associated with the absolute temperature observation (or prediction). (F) Relative error (predicted/observed) is another way to assess a simulation's quality.

While probably not important for data sets reflecting a month-long time-step, it would seem that the method outlined by Ringuest would be an improvement to Theurer's approach.

Another technique that has been advocated in the literature as a "reliability index" for simulation models is that of Leggett and Williams (1981). Gordon (1981) used similar measures. This method computes a percent deviation statistic that is supposed to measure the overall reliability of a model. This approach, however, implies that we can tolerate larger errors at higher temperatures because they are based on percent error (as in Figure 34f), which is obviously not the case.

It is not clear to me that many of the improvements advocated in the literature are warranted in the face of observed data that clearly violate the assumptions for the most commonly used statistical tests, such as independence of the observed data (autocorrelation) and measurement without bias. The problem of autocorrelation is substantially increased when using daily time-step simulations (yesterday's high temperature influences today's minimum, which in turn influences today's average temperature). In addition, we know that there are errors in the estimation or measurement of model input values, and errors in observed system response (water temperature). Finally, the errors usually do not have zero mean, normal distribution, and constant variance. Thus, it is certainly incorrect to ascribe all differences between predicted and observed water temperatures as model errors. In addition, the issue of validating the SNTMP model is clouded if the internal regression models have been used to fill or smooth extensive data gaps.

Model users should be especially skeptical of the observed data when major, unexplained differences between observed and simulated values occur (Theurer 1982; Donigian 1983). For example, Waddle (1987) repeatedly showed that the SSTEMP model, in conjunction with a dose of skepticism, was quite capable of identifying errors in observed data.

In addition, there are, or should be, questions related to the representativeness of observed temperature data. If "validation" temperatures are measured 1 km below a reservoir, the measurements will not provide nearly as robust a measure of validity as measurements taken 30 km downstream. (Of course the critical question really revolves around where the biological effects will be felt, but you get the idea.)

The whole subject of model validation, especially for the type of model we are using, is a complicated matter. For further study of these confirmation issues, the ambitious reader is referred to Chapra and Reckhow (1983), Reckhow and Chapra (1983), and Reckhow et al. (1986) for fairly exhaustive treatment. The dubious reader may refer to an interesting paper called "Statistical Analysis and the Illusion of Objectivity" by Berger and Berry (1988).

The bottom line is that no matter how well you have "validated" your model, employment of that model with an informed skepticism of both the model and the observed data will improve its use (Donigian 1983). I can say with little doubt that we are underestimating the prediction errors, but I do not know how much. This will have to remain the case until there is a well-accepted validation

methodology that can handle "messy-data" simulation models. Use the root mean squared error until those better methods are developed. Then, during calibration, simultaneously attempt to maximize the R^2 value and minimize the mean error.

OTHER STREAM TEMPERATURE MODELS

Over the past several decades, many models have been assembled to describe and predict stream temperatures. These models have taken several forms and have specialized in different ways. In particular, there appear to be two main categories of models: empirical and physical-process-oriented models. The empirical models are themselves of two forms: regression and stochastic/ descriptive. The process-oriented models are harder to classify because they usually specialize in certain types of processes, such as dynamic flow versus steady flow, mean daily versus hourly, and specific temperature versus equilibrium. The following sections will deal with each of these major types, but no true evaluation will be made.

Physical-Process Models

Steady-flow models. All physical-process models are a variation on the energy budget theme. That is, they attempt to explain the changes in water temperature by calculating the gains and losses in thermal energy from individually described phenomena such as radiation, convection, conduction, and evaporation. Early models were necessarily crude due to lack of appropriate instrumentation; however, application to large rivers was reasonably successful. In effect, it was hard to be wrong in large rivers due to the large heat storage capacity of that much water.

Brown (1969) illustrates this point by comparing a stream with a summer flow of 1 cfs having a diurnal fluctuation of 11.1 °C (20 °F), with a 5,000 cfs river having a diurnal fluctuation of only 1.1 °C (2 °F). Brown went on to develop more detail in his energy budget models to more accurately describe temperature phenomena in small streams, particularly with respect to the effects of riparian shading. His work has largely been the basis for further refinement in the art of temperature modeling (Hughes 1976; Currier and Hughes 1980). Most of these models, however, should be limited to reaches less than 2,000 feet in length (Currier and Hughes 1980).

A very widely used and accepted model for stream water quality modeling is QUAL-IIE. Though intended for up to 15 water quality constituents, QUAL-IIE could be used exclusively for temperature modeling. The model can handle slowly varying flow conditions and can simulate diurnal temperature, algal production, and dissolved oxygen. This model is reputedly inexpensive and easy to apply, being implemented on microcomputers. The model, user's manual, and technical assistance are available from the Environmental Protection Agency (EPA) Center for Water Quality Modeling in Athens, Georgia.

Another alternative to the SNTMP category of temperature models is TEMP-84,⁵ developed and applied by the Forest Service (Ellis et al. 1980; Beschta and Weatherred 1984). Though still a physical process model, it differs from the Theurer-type models in several respects. First, it is primarily intended to simulate potential maximum temperatures resulting from shade removal in small mountain streams at low flow. Because this is its single focus, minimal attention is given to many meteorological parameters, such as cloud cover and wind speed. Instead, the model contains more resolution in two areas: (1) the shade components include brush and logs in addition to topographic and riparian vegetation, and (2) the heat flux with the streambed is simulated through time in detail. This is important because this model simulates essentially on a 15-minute time-step; solar radiation is assumed to be absorbed by the substrate if the depth is less than 20 cm and the particle size is greater than 25 cm. Radiation is assumed to be absorbed during the day and released at night. The model has not been validated to date. The model, user's manual, and technical assistance are available from the Forest Service Watershed Systems Development Group in Fort Collins, Colorado.

A model called STEADY is an alternative stream temperature and dissolved oxygen model. STEADY, as you might imagine, is for steady flow situations. It has strengths in handling complex network structures, e.g., branches and loops, that the Theurer model will not handle. However, the input data must include the equilibrium water temperatures, thus implying that at least some other temperature model must be employed as well.

The historical development of physical-process-model development and application may be found in Edinger et al. (1974) and Carroll et al. (1983). Other theoretical mathematical models have been outlined in the literature (Raphael 1962; Nobel 1979), but in general offer no additional insight into applied temperature modeling. The major differences seem to be which heat flux terms are ignored, either explicitly or implicitly, and how coefficients were derived or estimated. One noteworthy exception is an interesting paper that develops a graphical technique to estimate the average equilibrium temperatures about which the instantaneous temperature oscillates (Krajewski et al. 1982). A worthwhile research endeavor would be to compare alternative temperature model formulations and empirical coefficients for consistency among models and to point out errors of commission or omission.

Dynamic flow models. Though stream flow is seldom truly steady, approximations to steady flow greatly simplify the description of all physical processes involved in temperature and other water quality modeling. As long as the stream or river has small, monotonic, changes in flow, we can continue to use steady flow models. If, however, the flow changes are large and erratic, we must employ models that can handle dynamic conditions. Jobson and Keefer (1979) present an example of modeling the thermal regime of the Chattahoochee River near Atlanta, Georgia, in highly transient flow situations. Modeling the dynamic flow environment was necessary because of hydropulsation (due to power generation) from 15.4 cms to 215 cms within 10 to 20 minutes.

⁵There is now, I believe, a version for microcomputers called TEMP-86.

The first challenge in such a situation is to model the routing of dynamic flow. Such a model must accurately describe the changes in velocity throughout the length of the segment (and thus travel time) that occur with cyclic flows. Travel times varied from 23.31 to 7.7 hours in the 27.9 km Chattahoochee reach modeled. This case was also complicated due to large interchanges in water from the main channel into or out of several tributaries as the stage changed in the main channel. Reverse flows were often observed during rising stage conditions. They found good correlation between measured and predicted stage after implementing a routine to vary several subreach roughness values linearly as a function of stage, though data collection requirements were extensive. In addition, they found that the roughness values seemed to vary with time at certain locations.

Modeling of temperature was accomplished next using input data much the same as any other physical-process-oriented model. The only difference was in the form of the heat transport equation and the time-step involved. Significantly more complicated descriptions of the solar radiation (to account for hourly changes in stream shading) were necessary. Dynamic temperature predictions were good (RMS errors of 0.32 °C and 0.20 °C, 0.6 °F and 0.4 °F) for the two months studied). They demonstrated that hydropeaking could increase the river temperature immediately below the dam by as much as 3 °C (5.4 °F) almost instantaneously, due to the greater release of epilimnionic water at high flows. Other water quality attributes, such as dissolved oxygen), were expected to change dramatically also, but they did not measure this.

Twenty-eight kilometers downstream, these same effects were attenuated and to some extent reversed. That is, large flushing flows were capable of reducing stream temperatures instead of raising them prior to the arrival of the warmer epilimnionic waters. The interpretation of the thermal effects of hydropeaking are complicated because they depend on the time of day and prior release schedules.⁶

That these same conclusions can be reached more simply through observation rather than dynamic modeling has been shown by Waddle (1987). Waddle limited the view to a specific time of year, as did Jobson, but was able to discern the general pattern of timing lags for temperature releases from a shallow reservoir at several points downstream and make limited recommendations for the timing and magnitude of flow releases necessary to mitigate consequences on a downstream fish hatchery. Once again, much additional data must be collected to quantitatively support the conclusions.

CE-QUAL-RIV1 is a model specializing in time-varying, highly unsteady flow and water quality assessment. Data input requirements are more extensive than steady-state counterparts. Both models, user's manuals, and technical assistance

⁶It is also interesting to note that what was described as a "light rain" apparently resulted in an increase of 1.2 °C (2.2 °F) during a period of otherwise steady flow.

are available from the Corps of Engineers Waterways Experiment Station, Vicksburg, Mississippi (U.S. Corps of Engineers 1987).

In addition, it is worth noting that a model capable of simulating dynamic flow situations can be used equally well to simulate steady flow events. An excellent paper by Laenen and Hansen (1985) describes just such an application of Jobson's dynamic flow/temperature model. It is also an application noteworthy for producing fair simulation results with a paucity of input data, as well as an unusually good problem statement and description of objectives. It is unfortunate that these dynamic flow studies typically cover only a few days time, due largely to the quantity of input data required (i.e., expense). It has been reported that complete dynamic-flow, dynamic-meteorology models are highly accurate, but require equally complete input data sets (Jobson 1981). An example of such a model is the Branched Lagrangian Transport Model (BLTM) developed by Jobson (1987).

A comparative study of a variety of solutions for dynamic heat flux and transport models may be found in Gosink (1986).

Statistical Models

We covered regression models earlier, primarily emphasizing the filling of missing data values. These empirical models do not attempt to explain heat flux or heat transport, but rather describe (1) the relationship between one or more easily measured meteorological variables and water temperature or (2) the relationship between water temperature and time of the year.

The first method has been tried with varying degrees of success. Water temperatures generally mimic air temperatures, but with a delay. The delay is termed a "phase shift." Several authors have studied this phenomena. Moore (1967) found disappointing results in attempting to correlate air temperature and discharge with water temperature in Oregon streams. Smith (1981) produced acceptable results with standard errors of up to 2.65 °C (4.8 °F).

The second method is often called harmonic analysis. Such relationships may be developed for any measurement of temperature: monthly, daily, maximum, mean, etc. For example, several authors (Collins 1969; Steele 1978, 1983; Smith 1981) used a variation on the single model:

$$T_{max} = a [\sin (bx + c)] + T$$

where T_{max} = maximum temperature for time x

a = amplitude, °C

b = constant, 0.0172 radians (0.987 degrees) per day

c = phase angle, radians

x = Julian day

T = mean annual maximum temperature, °C

Results of these investigations are predictable: (1) the water temperature data is usually assumed to be normally distributed; (2) the models invariably explain about 85% of the variance by using only the first harmonic; (3) standard deviations increase in the summer, peaking about the time of summer solstice, and decrease in the winter near the time of winter solstice; (4) limited data sets provide about the same statistical "explanatory" power as complete data sets, thus some data collection efforts may be reduced; and (5) care must be taken if periods of frozen water are included.

Though statistical models may be useful in general stream characterization studies, determining suitability for aquatic life (evaluating success for a potential introduction or predicting presence/absence of a species), they are generally of limited utility in determining the incremental impact on temperatures due to any change in the water system (e.g., flows, shade, reservoir, or construction) because any change in the stream geometry or hydrology (or meteorology) cannot be a part of the model. At best, they can identify that some changes have occurred in a basin (Steele 1983). But once man or nature changes the environment of the stream, the purely empirical models no longer describe the results. In addition, even if one does apply such a model, it is only representative of the single geographic location for which it was built; no translations are possible. For this reason Theurer's confined use for these statistical models to data filling and smoothing is very appealing.

The ambitious reader may be interested in extensions to these models: some append Monte Carlo routines to deal with the remaining 15% of the variance that the single harmonic models do not explain (Song and Chien 1977); some attempt to offer greater "predictive" ability using Kalman Filters (Chiu and Isu 1978); and some are interested in trend analysis, given the statistical problems of nonnormal distributions, missing values, and serial correlation (Hirsch et al. 1982). This last reference quotes another source (p. 117) for something we need to be cognizant of

No ... obvious indication advises the experimenter that a parametric assumption has been violated. Of course he may apply time-consuming tests for normality or homogeneity to the obtained data, but such tests are rather unsatisfactory. They are unlikely to detect any but the most extreme violations when samples are small, and they are almost certain to detect the most trivially slight violations when samples are large.

In summary, the purely statistical models lend themselves well to temperature prediction when the stream geometry and hydrologic conditions are not expected to change dramatically and long periods of record are available. Their development time is relatively rapid. The process-oriented models are better suited to exploration of system changes and alternative water management solutions, but at the cost of more intensive data collection, data entry, and manual calibration. See Marceau et al. (1986) for a more detailed discussion of these issues.

SPECIAL CASES

Predicting Temperature Extremes

Predicting daily temperature extremes is more challenging than predicting mean daily temperatures. Numerous issues come into play, some quite complicated.

Both the SSTEMP and SNTEMP models suffer from the disadvantage of untrustworthy maximum temperature simulations and predictions. The thrust of the SNTEMP model development was mean daily temperatures, and mean daily temperatures are what it does best and are the only output that has been "validated." The maximum daily temperature estimation was perhaps something of an afterthought and suffers from the following problems:

1. The calculations involved are themselves empirical, not theoretical. It is a matter of getting an essentially instantaneous temperature out of an otherwise daily average model. Theurer et al. (1984, pages 11-30 to 11-32), discuss the derivation of a way to estimate the average afternoon air temperature, the major component of estimating the maximum daily water temperature. Regression coefficients were determined for "normal" meteorological conditions at 16 selected weather stations around the country. Table II-3 (in Theurer et al. 1984) shows the R-values, standard deviations, and probable differences for each of the 16 stations and for all stations combined. Each of these three statistics is noticeably poorer for all stations combined than for most of the individual stations. This means that we are not sampling from the same underlying distribution. This is evident in the tabled regression coefficients (a_0 , a_1 , a_2 , and a_3), which are highly variable, often by an order of magnitude, as well as varying from positive to negative.

This could be improved by performing this same regression for only the local meteorology at each specific study area. There is a provision to substitute your own a_0 to a_3 coefficients in the job control file. (See Theurer et al. 1984, 111-80, record 7, fields 33 to 64.)

2. Correcting the regression coefficients, however, is not likely to fully correct the maximum daily water temperature calculations in areas within about six hours travel time from either reservoirs or major tributaries with markedly different mixing temperatures. The reason is that SNTEMP doesn't "know" anything about upstream conditions in predicting maximum temperatures. The program extends the current reach's stream geometry "indefinitely" upstream to simulate the conditions through which the water must travel from solar noon (assumed mean daily water temperature) to solar sunset (assumed maximum daily water temperature). This in itself is a major limitation of the model, only partially corrected in the SSTEMP program. More finely subdividing the reaches may help correct this problem.

3. The distance the model looks upstream to find the water at solar noon is a function of flow, width, and Manning's n , all of which are average values. Many people have a feel for Manning's n values only by experience with one of the National Ecology Research Center's hydraulic simulation models, IFG4. Such experience, however, may be misleading because the Manning's n values in IFG4 are really not hydraulic retardance values at all, but rather act as velocity

adjustment factors—a nice name for a fudge factor. Manning's n values derived from a water surface profile (WSP) type simulation are likely to be much more representative. Consultants from Woodward Clyde have told me that measurements of Manning's n from hydraulic simulations can be "very inaccurate" compared with actual measurements from time-of-travel studies. The fact that n or travel time both vary with discharge, especially at low flows, confounds the situation.

Each of the above reasons taken independently, and certainly combined, means that one should always treat the maximum daily water temperature predictions from SNTEMP with care and should subject the predictions to validation.

Corrections for the coefficients and Manning's n should both help. Neither, however, will eliminate the problem with "looking" upstream. This is an area for improvement in the programs. Indeed, Woodward Clyde Consultants have apparently made proprietary improvements to the maximum temperature algorithms by changing the way the model "remembers" what is upstream. Their improvements show better correspondence with observations (Voos, pers. comm.). Even with these changes though, the models leave something to be desired.

The bottom line is that if maximum temperatures from SNTEMP prove unsatisfactory with the incorporation of localized a0 to a3 coefficients, the development of a regression model that includes the mean daily water temperature and appropriate meteorological parameters in a fashion similar to the approach outlined in Theurer et al. (1984) is in order. Standard statistical techniques for inclusion or exclusion of parameters should be done. Occasionally, innovative approaches will be required, as mentioned in the earlier section on filling missing water temperature values.

Assessing Probability of Occurrence

A common problem in predicting temperature response arises in what may be called a worst-case analysis. The problem may be generically characterized as follows:

You are charged with determining the temperature response of a stream as a function of reservoir release. Maximum daily temperature for the length of a specified stream reach is the criterion; the 60-day period from July 15 to August 15 is known, by inspection, to be the time of worst case conditions. In

⁷I believe that an empirical (regression) model would perform better than SNTEMP in predicting maximum daily water temperature, using the existing program's prediction of mean daily water temperature and site-specific meteorological parameters as independent variables. This must of course be couched in terms of the assumptions underlying any regression—that the fundamental system properties have not changed. That is, no changes may be made to the stream geometry and the hydrologic conditions simulated must be in the bounds of measured conditions. In addition, the predictions so generated are valid only at the specific site for which measurements have been made. We have not tried this approach and therefore cannot attest to its reliability.

this example, the reservoir release temperature is not expected to vary, nor will the stream geometry (e.g., shading, width) vary. The meteorological conditions (air temperature, relative humidity, solar radiation, wind speed, percent possible sun), however, will be naturally varying.

There are at least two specific management questions that could be asked. First, what is the probability of exceeding a certain water temperature? For example, with a constant release of 25 cfs, how many days during the 60-day period are we likely to exceed 20 °C (68 °F)? Second, what flow is necessary to keep water temperatures from exceeding a specified threshold on any day within the 60-day period?

The first question is the most demanding to answer. One method is to gather and enter 30 years (the meteorological standard for "normal") worth of meteorological data for that 60-day period, run the simulation with the calibrated model, and tabulate the water temperature frequencies. Another method is to gather the meteorological data and develop joint frequency distributions for each parameter such that a Monte Carlo type simulation may be developed (Richardson 1981). Both methods are costly to develop, but may be warranted in situations demanding a rigorous answer.

The second question is probably more tractable if one is willing to live with a somewhat less accurate answer. First, refer to the sensitivity analysis performed during calibration to determine which parameters can be safely ignored. For example, using the standards from Figures 3 and 4, we might determine that averages for percent possible sun, solar radiation, and wind speed are acceptable. (Alternatively, since maximum temperatures are the issue, one might use 100% possible sun and maximum solar radiation.) However, air temperature and relative humidity appear too sensitive and variable to simply average. Inspection of the record shows that mean air temperatures commonly exceed 27 °C (80.6 °F), with occasional extremes of 32 °C (90 °F) (Figures 35 and 36). Relative humidity for the same period commonly varies from 40% to 80%. Simple trials with the model show that low air temperature and low humidity produce the lowest water temperatures; high air temperatures and high humidity produce the highest water temperatures; and the other combinations (high air temperature-low humidity, low air temperature-high humidity) produce virtually identical water temperatures. Furthermore, inspection of the record also shows that the highest air temperature never occurs in combination with high humidity, thus a purely "worst case" is beyond reality. So what is a person to do?

A practical response would seem to be that, like the development of conditional probabilities, we perform a regression or other fitting technique between air temperature and relative humidity. Air temperature should be the independent variable because it is the more sensitive of the two. Use this relationship to estimate the relative humidity that would occur with the highest (or 5% exceedence) recorded air temperature. The standard error of the estimate may be used to increase this humidity level if desired. Your predictive analysis should then include the highest air temperature and its associated relative humidity.

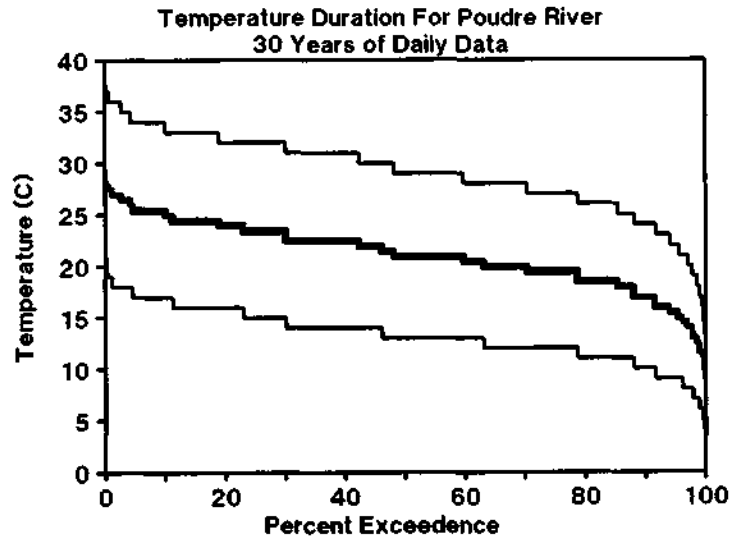

Figure 35. Duration plot for 30 years of daily air temperature from June 15 to August 15. Thin lines show the maximum and minimum temperatures, the thick line traces the mean air temperature. Each duration curve has been computed separately, i.e., any given mean temperature is not associated with its corresponding maximum and minimum temperatures. Curves are jagged due to the resolution of the original data.

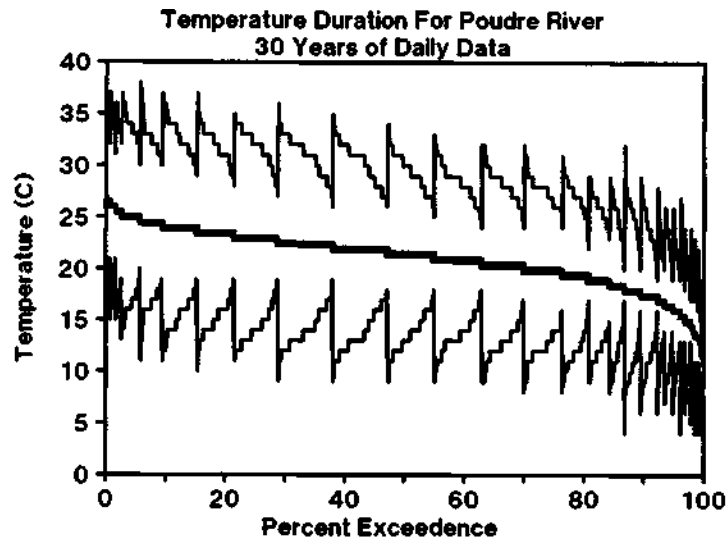

Figure 36. Duration plot for 30 years of mean daily air temperature from June 15 to August 15. The thick line traces the mean air temperature exceedance curve. The thin lines show the maximum and minimum temperatures given the corresponding mean. In other words, a variety of maximum and minimum conditions may each produce the same mean temperature. Curves are jagged due to the resolution of the original data.

The latter approach can then be used to answer the first question; namely, what is the probability of exceeding a certain water temperature? To do so, work your way along the air temperature exceedence curve, computing the associated relative humidities, holding the discharge constant, or for a projected release, and computing the water temperature by using your model. For example, suppose you find that the 7% exceedence air temperature (air temperatures this high or higher are found only 7% of the time) produces the threshold water temperature. Then it is reasonable to believe that the water temperatures themselves will be exceeded 7% of the time.

Note that this approach risks overlooking some combinations of meteorological parameters that could produce more extreme water temperatures. It also ignores the cross-correlation between the meteorological parameters for which we used averages. However, I feel that this heuristic approach is satisfactory in the face of the more detailed and costly simulation of long time-periods or Monte Carlo approaches.

The best example of investigating temperature recurrence intervals, of which I am aware, may be found in Moore's (1967) analysis of Oregon streams. He developed a rating scale, from one to six, to characterize the maximum July and August water temperatures based on the deviation of air temperature from normal for that time of year. For example, a scale value of one was given to a month when its air temperature departure from the long-term average for that month was greater than -4 °F; a two for -2 to -4 °F; a three for -2 to 0 °F; a four for 0 to $+2$ °F; a five for $+2$ to $+4$ °F; and a six for greater than $+4$ °F. These determinations were subject to slight modification on the basis of that month's discharge being above or below average. Moore felt that this scale could be used to deduce the recurrence interval for peak water temperatures based almost solely on air temperature. Other, more rigorous, analysis techniques substantiated this rudimentary approach, except in spring-fed streams.

A related issue involves not the probability of exceeding a specified temperature threshold for a single occurrence (day), but rather the probability of exceeding a threshold for a sequence of days. This has been done for rainfall, but to my knowledge, has not been done for maximum daily temperatures, either air or water. It has often been noted that "the longer the [dry] spell has lasted, the more likely it is to last another day" (Williams 1952). The ambitious practitioner is referred to a paper by Weiss (1964) that outlines an approach to developing a Markov-chain probability model to compute the cumulative probability of a sequence of events with a specified duration. One application, though actually related to toxic chemicals, that looks at the interrelated duration probabilities of river flows, chemical discharges, and toxic kinetics may be found in Hamelink (1979). We will need to be able to do these kinds of persistence analyses to proceed with more rigorous biological assessments and predictions. Some tools are being developed that may support forecasting of this sort. Though preliminary in nature, the Agricultural Research Service is developing a computer program called CLIMATE to predict, on a site-specific basis, the weather sequences of precipitation, maximum and minimum air temperatures, and solar radiation (D.A. Woolhiser, U.S. Department of Agriculture, Agricultural Research Service, pers. comm.).

To end on a positive note, it has been shown that analysis of data for a mere two-year time-span leads to the same general distribution of equilibrium water temperatures as does a ten-year time-span (Hogan et al. 1973). Presumably, this may mean that we could consider a two-season data collection effort comprehensive in the sense of giving us an appropriate mean and standard deviation for water temperatures. Knowing the standard deviation, one could easily compute the n-th exceedence value.

LITERATURE CITED

- Ambrose, R.B., T.O. Najarian, G. Bourne, and M.L. Thatcher. 1981. Models for analyzing eutrophication in Chesapeake Bay watersheds: a selection methodology. Chesapeake Bay Program, USEPA, Annapolis, MD.
- American Association for the Advancement of Science. 1988. Water not quite everywhere, but probably enough to drink. AAAS Observer, pp. 12-13.
- Anderson, H.W. 1973. The effects of clearcutting on stream temperature: a literature review. DNR Rep. 29. Washington Dept, of Nat. Res., Olympia. 24 pp.
- Anderson, J.W., and L. Miyajima. 1975. Analysis of the Vincent Creek fish rearing pool project. USDI Bureau of Land Management Technical Note 274. Denver, CO. 25 pp.
- Anderson, L.J. 1955. Instrumentation for mass-transfer and energy-budget studies. Pages 35-45 in M.H. Staatz and A.F. Trites, eds. Geology of the Quartz Creek Pegmatite District, Gunnison County, Colorado. USGS Prof. Paper 265.
- ASTM. 1983a. Standard method for verification and calibration of liquid-in-glass thermometers. Annual Book of ASTM Standards, Designation E77-82. 890 pp.
- ASTM. 1983b. Standard specification for ASTM thermometers. Annual Book of ASTM Standards, Designation E1-83. 890 pp.
- ASTM. 1983c. Standard definitions of terms relating to temperature measurement. Annual Book of ASTM Standards, Designation E344-79. 890 pp.
- Bark, A.W., D.W. Cartwright, C.S. Lovatt, and J.M. Watts. 1986. A simple and inexpensive monitor for recording oxygen and temperature in lakes and reservoirs. Water Resour. 20(8):1005-1010.
- Bartholow, J.M. 1977. Fort Niobrara Refuge: big game management modeling. M.S. Thesis. Colorado State University, Fort Collins. 207 pp.
- Bartholow, J.M. [1987b.] Stream reach solar model (SSSOLAR). Temperature model technical note no. 6. Computer program and documentation for IBM-PC. U.S. Fish and Wildlife Service, Fort Collins, CO. 6 pp. Unpubl. MS.

- Bartholow, J.M. [1988a.] Stream segment shade model (SSSHADE). Temperature model technical note no. 3. Computer program and documentation for IBM-PC. U.S. Fish and Wildlife Service, Fort Collins, CO. 8 pp. Unpubl. MS.
- Bartholow, J.M. [1988b.] Stream segment solar model (SSSOLAR). Temperature model technical note no. 4. Computer program and documentation for IBM-PC. U.S. Fish and Wildlife Service, Fort Collins, CO. 8 pp. Unpubl. MS.
- Bartholow, J.M. [1988c.] Stream segment temperature model (SSTEMP). Temperature model technical note no. 2. Computer program and documentation for IBM-PC. U.S. Fish and Wildlife Service, Fort Collins, CO. 12 pp. Unpubl. MS.
- Bartholow, J.M., and T.J. Waddle. 1986. Introduction to stream network habitat analysis. Instream Flow Information Paper 22. U.S. Fish Wildl. Serv. Biol. Rep. 86(8). 242 pp.
- Barton, D.R., and W.D. Taylor. 1985. Dimensions of riparian buffer strips required to maintain trout habitat in southern Ontario streams. North Am. J. Fish. Manage. 5:364-378.
- Benham, D.G., and D.G. George. 1981. A portable system for measuring water temperature, conductivity, dissolved oxygen, light attenuation and depth of sampling. Freshwater Biol. 11:459-471.
- Berger, J.O., and D.A. Berry. 1988. Statistical analysis and the illusion of objectivity. Am. Sci. 76:159-165.
- Beschta, R.L., and J. Weathered. 1984. TEMP-84, a computer model for predicting stream temperatures resulting from the management of streamside vegetation. USDA Watershed Systems Development Group. WSDG Report WSDG-AD-00009. 76 pp.
- Beschta, R.L., and R.L. Taylor. 1988. Stream temperature increases and land use in a forested Oregon watershed. Water Resour. Bull. 24(1):19-25.
- Bilby, R.E. 1984. Characteristics and frequency of cool-water areas in a western Washington stream. J. Freshwater Ecol. 2(6):593-602.
- Blackadar, A.K. 1983. Using home computers to study the weather. Weatherwise 36(4):193-195.
- Blackadar, A.K. 1984. A computer almanac. Weatherwise 37(5):257-260.
- Blackburn, T. 1983. A practical method of correcting monthly average temperature biases resulting from differing times of observation. J. dim. App. Meteorol. 22(2):328-330.
- Boning, C.W. 1974. Generalization of stream travel rates and dispersion characteristics from time-of-travel measurements. J. Res. U.S. Geol. Surv. 2(4):495-499.

- Bovee, K.D. 1982. A guide to stream habitat analysis using the Instream Flow Incremental Methodology. Instream Flow Information Paper 12. U.S. Fish Wildl. Serv. FWS/OBS-82/26. 248pp.
- Brazier, J.R., and G.W. Brown. 1973. Buffer strips for stream temperature control. Research Paper 15. Forest Research Laboratory, School of Forestry, Oregon State University, Corvallis. 9 pp.
- Brown, G.W. 1969. Predicting temperatures of small streams. Water Resour. Res. 5(1):68-75.
- Brown, G.W. 1970. Predicting the effect of clearcutting on stream temperature. J. Soil Water Conserv. 25:11-13.
- Burton, T.M., and G.E. Likens. 1973. The effect of strip-cutting on stream temperatures in the Hubbard Brook Experimental Forest, New Hampshire. Bioscience 23:433-435.
- California Department of Water Resources. 1976. Eel-Russian Rivers streamflow augmentation studies. Bulletin No. 105-5. Sacramento, CA. 41 pp. + appendices.
- Carroll, T.A., R.D. Nobel, and R.G. Buschman. 1983. Analytical prediction of the hourly temperature variation in rivers. J. Environ. Syst. 12(3): 279-288.
- Cassidy, R.A., and G.D. Holmes. 1980. Temperature and turbidity control downstream of a reservoir with multilevel withdrawal capability. Pages 761-771 in H.G. Stefan, ed. Proceedings of the symposium on surface water impoundments. American Society of Civil Engineers. Paper 5-5.
- Cinquemani, V., J.R. Owenby, and R.G. Baldwin. 1978. Input data for solar systems. U.S. Dept. of Energy. Environ. Resour. and Assess. Branch. 192 pp.
- Chapra, S.C., and K.H. Reckhpw. 1983. Engineering approaches for lake management. Volume 2: mechanistic modeling. Butterworth Publishers, Boston, MA. 492 pp.
- Chiu, C., and E.O. Isu. 1978. Stream temperature estimation using Kalman filter. Am. Soc. Civ. Eng. Proc. [HY 9 no. 13991] 104:1257-1268.
- Collins, M.R. 1969. Temperature analysis of a stream. USGS Professional Paper 650-B. pp. B174-B179.
- Colorado Climate Center. 1988. Colorado climate newsletter. Department of Atmospheric Science, Colorado State University, Fort Collins. 11 pp.
- Comer, L.E., and W.J. Grenney. 1977. Heat transfer processes in the bed of a small stream. Water Res. 11(8):743-744.
- Coutant, C.C., K.L. Zachman, O.K. Cox, and B.L. Pearman. 1984. Temperature selection by juvenile striped bass in laboratory and field. Trans. Am. Fish. Soc. 113:666-671.

- Cowx, I.G., W.O. Young, and J.P. Booth. Thermal characteristics of two regulated rivers in Mid-Wales, U.K. *Regul. Rivers* 1:85-91.
- Crisp, D.T., and G. Howson. 1982. Effect of air temperature upon mean water temperature in streams in the North Pennines and English Lake District. *Freshwater Biol.* 12:359-367.
- Crittenden, R.N. 1978. Sensitivity analysis of a theoretical energy balance model for water temperatures in small streams. *Ecol. Model.* 5:207-224.
- Croley, I.E., A.R. Giaquinta, and R.A. Woodhouse. 1981. River thermal standards costs in the upper midwest. *Am. Soc. Civ. Eng., J. Energ. Div. Proc.* 107(EY1):65-77
- Currier, J.B., and D. Hughes. 1980. Temperature. Chapter VII in *An approach to water resources evaluation of non-point silvacultural sources (a procedural handbook)*. U.S. EPA Environmental Research Lab. Athens, GA. [EPA-600/ 8-80-012] NTIS PB81-119828. v.p. (approx. 780 pp.)
- Devries, A.L. 1971. Freezing resistance in fishes. Pages 157-190 in W.S. Hoar and D.J. Randall, eds. *Fish physiology*. Academic Press, New York. 559 pp.
- Dodge, D.P., G.A. Goodchild, I. MacRitchie, J.C. Tilt, and D.G. Waldriff. 1984. Aquatic habitat inventory surveys. Ontario Ministry of Natural Resources.
- Donigian, A.S., Jr. 1983. Model predictions vs. field observations: the model validation/testing process. Pages 151-171 in R.L. Swann and A. Eschenroeder, eds. *Fate of chemicals in the environment: compartmental and multimedia models for predictions*. American Chemical Society. ACS Symposium Series 225. Washington, DC.
- Dymond, J.R. 1984. Water temperature change caused by abstraction. *J. Hyd. Eng.* 110(7):987-991.
- Edinger, J.E., O.K. Brady, and J.C. Geyer. 1974. Heat exchange and transport in the environment. Cooling water studies for Electric Power Research Institute. Research Project RP-49, Report No. 14. 125 pp.
- Ellis, S.S., S.L. Ponce, and L.E. Si verts. 1980. A temperature model for small mountain streams. Symposium on watershed management. *Am. Soc. Civ. Eng.* 1:494-503.
- Feller, M.C. 1981. Effects of clearcutting and slashburning on stream temperature in southwestern British Columbia. *Water Resour. Bull.* 17(5):863-867.
- Ferraro, F.A., A.E. Gaulke, and C.M. Loeffelman. 1978. Pages 125-136 in ASTM Special Publication #652. American Society for Testing and Materials. Philadelphia, PA. 184 pp.
- Ficke, E., and J.F. Ficke. 1977. Ice on rivers and lakes - a bibliographic essay. USGS Water-Resources Investigations 77-95. 173 pp.

- Forsythe, W.E. 1954. Smithsonian physical tables. Smithsonian Miscellaneous Collections Volume 120. Publication 4169. Smithsonian Institution, Washington, DC.
- Furman, R.W., and G.E. Brink. 1975. The national fire weather library: what it is and how to use it. USDA For. Serv. Gen. Tech. Rep. RM-19. Rocky Mt. For. Range Exp. Stn., Fort Collins, CO. 8 pp.
- Geiger, R. 1965. The climate near the ground. Harvard University Press, Cambridge, MA. 611 pp.
- Gibson, R.J. 1966. Some factors influencing the distribution of brook trout and young Atlantic salmon. J. Fish. Res. Bd. Can. 23(12):1977-1980.
- Gile, D.E., Jr. 1986. Temperature sensors: how they work, where they are used. Power 130(4):191-194.
- Gilroy, E.J., and T.D. Steele. 1972. An analysis of sampling-frequency alternatives for fitting a daily stream-temperature model. Pages 594-608 in International symposium on uncertainties in hydrologic and water resource systems proceedings.
- Goodall, C. 1983. Examining residuals. Pages 211-246 in D.C. Hoaglin, F. Hosteller, and J.W. Tukey, eds. Understanding robust and exploratory data analysis. John Wiley, New York. 447 pp.
- Gordon, J.A. 1981. LARM two-dimensional model: an evaluation. Amer. Soc. Civ. Eng., J. Environ. Eng. Div. 107(#EE5):877-886.
- Gosink, J.P. 1986. Synopsis of analytic solutions for the temperature distributions in a river downstream from a dam or reservoir. Water Resour. Res. 22(6):979-983.
- Gray, D.M., ed. 1970. Handbook on the principles of hydrology. Water Information Center, Port Washington, NY. v.p.
- Gunnison, D., J.M. Brannon, and R.L. Chen. 1986. Reservoir site preparation: summary report. Technical Report E-86-4, U.S. Army Engineer Waterways Experiment Station, Vicksburg, MS. 48 pp.
- Hamelink, J.L. 1979. A proposed method for deriving effluent limits from water quality criteria. Pages 122-127 in K.L. Dickson, A.W. Maki, and J. Cairns, Jr., eds. Analyzing the hazard evaluation process. Proceedings of a workshop held in Waterville Valley, NH, August 14-18, 1978.
- Hamilton, K., and E.P. Bergersen. 1984. Methods to estimate aquatic habitat variables. Colorado Cooperative Fishery Research Unit, Fort Collins, CO. v.p.
- Henriksen, J. 1988. Technical assistance - before or after. Instream Flow Chronicle 5(1):1-2. Colorado State University Office of Conference Services, Fort Collins.

- Hewlett, J.D., and J.C. Fortson. 1982. Stream temperature under an inadequate buffer strip in the Southeast Piedmont. *Water Resour. Bull.* 18(6):983-988.
- Hirsch, R.M., J.R. Slack, and R.A. Smith. 1982. Techniques of trend analysis for monthly water quality data. *Water Resour. Res.* 18(1):107-121.
- Hirtzel, C.S., J.E. Quon, and R.B. Corotis. 1982. Mean of autocorrelated air quality measurements. *J. Environ. Eng.* 17138, *Am. Assoc. Civ. Eng.* 108(EE3):488-501.
- Hogan, C.M., L.C. Patmore, and H. Seidman. 1973. Statistical prediction of equilibrium temperature from standard meteorological data bases. *Environmental Protection Technology Series. EPA-660/2-73-003. USEPA, Washington, DC.* 271 pp.
- Hoiling, C.S. 1978. *Adaptive environmental assessment and management.* John Wiley and Sons, NY. 377 pp.
- Hubbard, E.F., F.A. Kilpatrick, L.A. Martens, and J.F. Wilson, Jr. 1981. Measurement of time of travel and dispersion in streams by dye tracing. *USGS Techniques of Water-Resources Investigation, TWI 3-A9.* 44 pp.
- Hughes, D. [1976.] Prediction method for calculating potential water temperature increases and influence zones. Umpqua National Forest, P.O. Box 1008, Roseburg, OR 97470. 16 pp. Unpubl. MS.
- Hydroscience, Inc. 1971. Simplified mathematical modeling of water quality. U.S. Environmental Protection Agency, Washington, DC. 127 pp. + appendices and charts.
- Jackson, L.W.R., and R.S. Harper. 1955. Relation of light intensity to basal area of shortleaf pine stands in Georgia. *Ecology* 36:158-159.
- Jackson, R.D., and A.P. Jackman. 1980. Predicting the natural water temperature profile throughout a river basin. *J. Environ. Syst.* 9(4):361-381.
- Jobson, H.E. 1977. Bed conduction computation for thermal models. *Am. Soc. Civ. Eng. Proc.* 103[H410 No. 13251]:1213-1217.
- Jobson, H.E. 1981. Temperature and solute-transport simulation in streamflow using a Lagrangian reference frame. U.S. Geological Survey Water Resources Division. *Water Resources Investigations* 81-2. 175 pp.
- Jobson, H.E. 1987. Estimation of dispersion and first-order rate coefficients by numerical routing. *Water Resour. Res.* 23(1):169-180.
- Jobson, H.J., and T.N. Keefer. 1979. Modeling highly transient flow, mass, and heat transport in the Chattahoochee River near Atlanta, Georgia. U.S. Geological Survey Professional Paper 1136. 41 pp.

- Jewett, I.P., and M.P. Mosley. 1983. River temperature modeling. in Streamland, 14. National Water and Soil Conservation Organization, Water and Soil Division, Ministry of Works and Development. Wellington North, New Zealand. 4 pp.
- Kaya, C.M., L.R. Kaeding, and D.E. Burkhalter. 1971. Use of a cold-water refuge by rainbow and brown trout in a geothermally heated stream. Prog. Fish-Cult. 39(1):37-39.
- Kothandaraman, V., and R.L. Evans. 1970. Annual temperature variations in an impoundment in Central Illinois. J. Water Works Assoc. 62:639-642.
- Krajewski, W.F., A.K. Kraszewski, and W.J. Grenney. 1982. A graphical technique for river water temperature predictions. Ecol. Model. 17:209-224.
- Laenen, A., and R.P. Hansen. 1985. Preliminary study of the water temperature regime of the North Santiam River downstream from Detroit and Big Cliff Dams, Oregon. U.S. Geological Survey. Water-Resources Investigations Report 84-4105. 45 pp.
- Lafferty, B. 1987. A procedure for evaluating buffer strips for stream temperature protection under the forest practices act. Pages 70-77 in Managing Oregon's riparian zone for timber, fish, and wildlife. NCASI Tech. Bull. No. 514. 96 pp.
- Latimer, J.R. 1972. Radiation measurement. International Field Year for the Great Lakes Technical Manual Series No. 2. Atmospheric Environment Service, Environment Canada. The Secretariat, Canadian National Committee for the International Hydrological Decade, No. 8 Building, Carl ing Avenue, Ottawa, Canada. 53 pp.
- Leffler, R.J. 1981. Estimating average temperatures on Appalachian summits. J. App. Meteorol. 20(6):637-642.
- Leggett, R.W., and L.R. Williams. 1981. A reliability index for models. Ecol. Model. 13:303-312.
- Lemmon, P.E. 1956. A spherical densitometer for estimating forest overstory density. For. Sci. 2(1):314-320.
- Lifton, W.S., K.A. Voos, and D.A. Gilbert. 1985. The pit 3, 4 and 5 hydroelectric project using the USFWS instream temperature model. Presented at the Waterpower '85 International Conference on Hydropower. Am. Soc. Civ. Eng., Las Vegas, Nevada. 11 pp.
- Linsley, R.K., Jr., M.A. Kohler, and J.L.H. Paulhus. 1975. Hydrology for engineers, 2nd ed. McGraw-Hill Book Co., New York. 482 pp.
- List, R.J. 1951. Smithsonian meteorological tables. Smithsonian Miscellaneous Collections Volume 114. Publication 4014. Washington, DC.

- Lynch, J.A., G.B. Rishel, and E.S. Corbet. 1984. Thermal alteration of streams draining clearcut watersheds: quantification and biological implications. *Hydrobiologica* 111:161-169.
- Mankin, O.B., R.V. O'Neill, H.H. Shugart, and B.W. Rust. 1975. The importance of validation in ecosystem analysis. Pages 63-71 in G.S. Innis, ed. *New directions in the analysis of ecological systems, Part 1. Simulation Councils Proceedings Series 5(1)*.
- Marceau, P., D. Cluis, and G. Morin. 1986. Comparisons des performances relatives a un modele deterministe et a un modele stochastique de temperature de l'eau en riviere. *Can. J. Civ. Eng.* 13(3):352-364.
- McCombie, A.M. 1959. Some relations between air temperatures and the surface water temperatures of lakes. *Limnol. Oceanogr.* 4(3):252-258.
- Meehan, W.R. 1970. Some effects of shade cover on stream temperature in southeast Alaska. USDA For. Serv. Res. Note PNW-113. Pacific Northwest Forest and Range Experiment Station. 9 pp.
- Milhous, R.T., M. Updike, and D. Schneider. (1989). Physical Habitat Simulation System (PHABSIM) - Version II. National Ecology Research Center Report. Fort Collins, CO. In press.
- Millard, S.P., J.R. Yearsley, and D.P. Lettenmaier. 1985. Space-time correlation and its effects on methods for detecting aquatic ecological change. *Can. J. Fish. Aquat. Sci.* 42:1391-1400.
- Moore, A.M. 1967. Correlation and analysis of water-temperature data for Oregon streams. U.S. Geological Survey Water-Supply Paper 1819-K. 53 pp.
- Morhardt, J.E., D.F. Hanson, and P.O. Coulston. 1983. Instream flow: increased accuracy using habitat mapping. Pages 1294-1304 in *Waterpower '83*. An international conference on hydropower. Conference proceedings vol. 3: environmental impacts. Tennessee Valley Authority, Knoxville, TN.
- National Climatic Data Center. Periodic. Local climatological data, Asheville, NC.
- National Weather Service. 1973. Relative humidity and dew point table. U.S. Dept, of Commerce. National Oceanic and Atmospheric Administration. WS TA B-0-5A through E. 4 pp. each. [Suffix A is for elevations between 6101 and 8500 feet; B is for 3901 to 6100 feet; C is for 1900 to 3900 feet; D is for 501 to 1900 feet; E is for 0 to 500 feet.]
- Needham, P.R., and A.C. Jones. 1959. Flow, temperature, solar radiation, and ice in relation to activities of fishes in Sagehen Creek, California. *Ecology* 40:465-474.
- Neel, J.K. 1951. Interrelations of certain physical and chemical features in a headwater-limestone stream. *Ecology* 32(3):368-391.

- Nobel, R.D. 1979. Analytical prediction of natural temperatures in rivers. Am. Soc. Civ. Eng. Proc. [EE 5 no. 14870]:1014-1018.
- Nobel, R.D., and A.P. Jackman. 1980. Predicting the natural water temperature profile throughout a river basin. J. Environ. Syst. 9(4):361-381.
- Osterkamp, I.E. 1979. Mercury-in-glass thermometers for precise temperature measurements near 0 C. J. Glaciol. 22(87):385-388.
- Ozaki, V.L. 1988. Geomorphic and hydrologic conditions for cold pool formation on Redwood Creek, California. Redwood National Park Research and Development Technical Report 24. Redwood National Park, Arcata, CA. 57 pp. + appendices.
- Parton, U.J., and J.A. Logan. 1981. A model for diurnal variation in soil and air temperature. Agric. Meteorol. 23:205-216 and errata p. 219.
- Patton, D.R. 1973. A literature review of timber harvesting effects on stream temperature: research needs for the Southwest. USDA Forest Service Research Note RM-249. 4 pp.
- Pauszek, F.H. 1972. Water-temperature data acquisition activities in the United States. Water-Resources Investigations 2-72. U.S. Geological Survey, Washington, DC. 54 pp.
- Platts, W.S. 1981. Stream inventory garbage in-reliable analysis out: only in fairy tales. Pages 75-84 in N.B. Armantrout, ed. Acquisition and utilization of aquatic habitat inventory information: proceedings of a symposium, 1981 October 28-30, Portland, OR. Western Division, American Fisheries Society.
- Platts, W.S., W.F. Megahan, and G.W. Minshall. 1983. Methods for evaluating stream, riparian and biotic conditions. Gen. Tech. Rep. INT-138. Ogden, UT. Intermountain Forest and Range Experiment Station. 70 pp.
- Platts, W.S., C. Armour, G.D. Booth, M. Bryant, J.L. Bufford, P. Cuplin, S. Jensen, G.W. Lienkaemper, G.W. Minshall, S.B. Monsen, R.L. Nelson, J.R. Sedell, and J.S. Tuhy. 1987. Methods for evaluating riparian habitats with applications to management. General Technical Report INT-221. Ogden, UT: U.S. Dept. of Agric., Forest Service, Intermountain Research Station. 177 pp.
- Pope, D., and B. Lafferty. 1987. Selecting leave trees in a streamside management zone to minimize increases in stream temperature - Canton Creek. Pages 67-69 in Managing Oregon's riparian zone for timber, fish, and wildlife. NCASI Technical Bulletin No. 514. 96 pp.
- Quigley, T.M. 1981. Estimating contribution of overstory vegetation to stream surface shade. Wildl. Soc. Bull. 9(1):22-27.
- Raphael, J.M. 1962. Prediction of temperature in rivers and reservoirs. J. Power Div., Proc. Am. Soc. Civ. Eng. 88:157-181.

- Reckhow, K.H., and S.C. Chapra. 1983. Engineering approaches for lake management. Volume 1: data analysis and empirical modeling. Butterworth Publishers, Boston, MA. 340 pp.
- Reckhow, K.H., J.T. Clements, and R. Dodd. 1986. Statistical goodness-of-fit measures for waste load allocation models. Limnosystems, 2917 Wade Rd, Durham, NC 27705. 75 pp. [Draft Final Report.]
- Reifsnyder, W.E., and H.W. Lull. 1965. Radiant energy in relation to forests. USDA For. Serv. Tech. Bull. No. 1344. 111 pp.
- Richardson, C.W. 1981. Stochastic simulation of daily precipitation, temperature, and solar radiation. Water Resour. Res. 17(1):182-190.
- Ringuest, J.L. 1986. A chi-square statistic for validating simulation generated responses. Comput. Dper. Res. 13(4)-.379-385.
- Rishel, G.B., J.A. Lynch, and E.S. Corbett. 1982. Seasonal stream temperature changes following forest harvesting. J. Environ. Qual. 11(1):112-116.
- Rochelle, J.M., and C.C. Coutant. 1973. Temperature sensitive ultrasonic fish tag, Q-5099. Oak Ridge National Lab Report ORNL-TM-4438. Available from NTIS. 29 pp.
- Rocky Mountain News. July 30, 1988. Something fishy in drought aid bill.
- Ruthven, D.M. 1971. The dispersion of a decaying effluent discharged continuously into a uniformly flowing stream. Water Res. 5:343-352.
- Sanders, W.M. 1985. Field validation. Pages 601-618 In G.M. Rand and S.R. Petrocelli, eds. Fundamentals of aquatic toxicology. Hemisphere Publishing, Washington, DC. 666 pp.
- Sette, O.E. 1940. Probable temperatures of surface water to be stored above Shasta Dam. Pages 165-174 in H.A. Hanson, O.R. Smith, and P.R. Needham, eds. An investigation of fish-salvage problems in relation to Shasta Dam. USDI Bureau of Fisheries, Special Scientific Report No. 10, Appendix B.
- Shipman, R.D. 1954. Simple aid to instantaneous measurement of light intensity. J. For. 52(8):605-606.
- Shuter, B.J., D.A. Schlesinger, and A.P. Zimmerman. 1983. Empirical predictors of annual surface water temperature cycles in North American lakes. Can. J. Fish Aquat. Sci. 40:1838-1845.
- Smagorinsky, J., Chairman, Climate Research Board. 1982. Carbon dioxide: a second assessment. National Academy Press, Washington, DC.

- Smith, K. 1981. The prediction of river water temperature. *Hydrol. Sci.* 26(1):19-32.
- Smith, K., and M.E. Lavis. 1975. Environmental influences on the temperature of a small upland stream. *Oikos* 26(2):228-236.
- Song, C.C.S., and C. Chien. 1977. Stochastic properties of daily temperature in rivers. *J. Environ. Eng. Div., Am. Soc. Civ. Eng.* 103[EE 2 Paper 12858] Apr: 217-231.
- Song, C.C.S., and K.S. Leung. 1978. River temperature variation with freezing and storage. *Am. Soc. Civ. Eng. Proc.* [EE5 no. 14054] 104:879-888.
- Steele, T.D. 1978. A simple-harmonic model for depicting the annual cycle of seasonal stream temperatures. *USGS Open File Report* 78-155. 16 pp.
- Steele, T.D. 1983. Harmonic analyses of stream temperatures in the Upper Colorado River Basin. *USGS Water Resources Investigations Report* 84-4290. 57 pp.
- Stevens, H.H., Jr., J.F. Ficke, and G.F. Smoot. 1975. Water temperature, influential factors, field measurement and data presentation. *Techniques of water-resources investigations of the USGS. Book 1, collection of water data by direct measurement, chapter D1.* 65 pp.
- Swift, L.W., and J.B. Messer. 1971. Forest cuttings raise temperature of small streams in the Southern Appalachians. *J. Soil Water Conserv.* 26(3):111-116.
- Sylvester, R.O. 1963. Effects of water uses and impoundments on water temperature, 12th Pacific Northwest symposium on water pollution research. *U.S. Public Health Service, Corvallis, OR.* pp. 6-28.
- Tennessee Valley Authority. 1972. Heat and mass transfer between a water surface and the atmosphere. *Water Resour. Lab. Rep.* 14. Norris, TN. 166 pp.
- Tenney, A.S. 1987. How do you know how hot it really is? *Research/Development* 29(2):122-126.
- Terrell, J.W., T.E. McMahon, P.O. Inskip, R.F. Raleigh, and K.L. Williamson. 1982. Habitat suitability index models: Appendix A. Guidelines for riverine and lacustrine applications for fish HSI models with the Habitat Evaluation Procedures. *U.S. Fish Wildl. Serv. FWS/OBS-82/10.A.* 54 pp.
- Theurer, F.D. [1984.] Stand-alone shade model. Computer program and internal documentation. *U.S. Fish and Wildl. Serv., Fort Collins, CO.* Unpubl. MS.
- Theurer, F.D., and K.A. Voos. 1982. IFG's Instream water temperature model validation. Pages 315-318 in *Conference on water and energy: technical and policy issues. ASCE proceedings of the hydraulics conference, Pittsburgh, PA, and Fort Collins, CO, May 23-26 and June 23-27, 1982.*

- Theurer, F.D., K.A. Voos, and W.J. Miller. 1984. Instream water temperature model. Instream Flow Information Paper 16. U.S. Fish Wildl. Serv. FWS/OBS-84/15. approx. 200 pp.
- Theurer, F.D., I. Lines, and T. Nelson. 1985. Interaction between riparian vegetation, water temperature, and salmonid habitat in the Tucannon River. Water Resour. Bull. 21(1):53-64.
- Troxler, R.W., Jr., and E.L. Thackston. 1975. Effect of meteorological variables on temperature changes in flowing streams. Ecological Research Series EPA-660/3-75-002.
- U.S. Army Corps of Engineers. 1987. Water operations technical support information exchange bulletin. Environmental Laboratory, Waterways Experiment Station, Vicksburg, MS. Vol. E-87-1. 2 sheets.
- U.S. Department of Commerce. 1949. Weekly mean values of daily total solar and sky radiation. Weather Bureau Technical Paper No. 11. Washington, DC. 17 pp. [Supplement No. 1, 1955. 4 pp.]
- U.S. Department of Commerce. 1951. Sunshine and cloudiness at selected stations in the United States. Weather Bureau Technical Paper No. 12. Washington, DC. 16 pp.
- U.S. Department of Commerce. 1952. Normal weather charts for the northern hemisphere. Weather Bureau Technical Paper No. 21. Washington, DC.
- U.S. Department of Commerce. 1960. Climatological summary of the U.S. 1951-1960. Climatology of the U.S. No. 86. Asheville, NC.
- U.S. Department of Commerce. 1960. Summary of hourly observations. Climatology of the U.S. No. 82. Asheville, NC.
- U.S. Department of Commerce. 1968. Climatic atlas of the United States. Asheville, NC. 80 pp. [Reprinted 1983.]
- U.S. Dept. of Commerce. 1980. Daily normals of temperature, precipitation, and heating and cooling degree days 1951-80. Climatology of the U.S. No. 84. Asheville, NC.
- U.S. Department of Commerce. [Published every 10 years.] Monthly normals of temperature, precipitation, heating and cooling degree days 1951-80. Climatology of the U.S. No. 81. Asheville, NC. v.p.
- U.S. Environmental Protection Agency. 1984. Technical support manual: waterbody surveys and assessments for conducting use attainability analyses, volume III, lake systems. Office of Water Regulations and Standards, Washington, DC. v.p.
- U.S. General Accounting Office. 1979. Guidelines for model evaluation. PAD-79-17. -Washington, DC. 31 pp. [Exposure Draft.]

- Viskanta, R., and J.S. Toor. 1972. Radiant energy transfer in waters. *Water Resour. Res.* 8(3):595-608.
- Waddle, T. 1987. Water temperature data analysis and simulation for the Salmon River, Oswego County, New York, 1986. Unpublished report for Empire State Electrical Energy Research Corp., 1271 Ave. of the Americas, New York, NY 10020.
- Ward, J.C. 1963. Annual variation of stream water temperature. *J. San. Eng. Div., Proc. Am. Soc. Civ. Eng.* 89(SA6):1-16.
- Webb, B.W., and D.E. Walling. 1988. Modification of temperature behavior through regulation of a British river system. *Regul. Rivers: Res. Manage.* 2:103-116.
- Weiss, L.L. 1964. Sequences of wet or dry days described by a Markov chain probability model. *Monthly Weather Rev.* 92(4):169-176.
- Wellner, C.A. 1979. Estimating light intensity beneath coniferous forest canopies: simple field method. USDA Forest Service Research Note INT-250. 3 pp.
- Williams, C.B. 1952. Sequences of wet and dry days considered in relation to the logarithmic series. *Q. J. Royal Meteorol. Soc.* 78(335):91-96.
- Wunderlich, W.O., and R.A. Elder. 1967. The mechanics of stratified flow in reservoirs. Pages 56-68 in *Reservoir fishery resources symposium*. Southern Div., Am. Fish. Soc., Washington, DC. 569 pp.
- Wunderlich, W.O., and M.C. Shiao. 1984. Long-range reservoir outflow temperature planning. *J. Water Resour. Plan. Manage.* 110:285-295.
- Zoltai, S.C. 1988. Ecoclimatic provinces of Canada and man-induced climatic change. *Canada Committee on Ecological Land Classification Newsletter* 17:12-15.

APPENDIX A. DATA SOURCES

Hydrodata/Climatedata US West Knowledge Engineering, Inc. 4380 South Syracuse Street Denver, CO 80237 303-694-4200	Meteorological and hydrologic data
National Climatic Data Center Federal Building Asheville, NC 28801-2696 704-259-0682 or FTS 672-0682	Meteorological data
U.S. Forest Service Fire Data Center 3905 Vista Ave. Boise, ID 83705 208-334-9458 or FTS 554-9458.	Meteorological data
WATSTORE NAWDEX Chief of User Services U.S. Geological Survey 421 National Center Reston, VA 22092 703-648-5664 or FTS 648-5664	Meteorological and hydrologic data

APPENDIX B. EQUIPMENT VENDORS

Ben Meadows Company 3589 Broad Street P.O. Box 80589 Atlanta (Chamblee), GA 30366 404-455-0907	General forestry supply
Climatronics 140 Wilbur Place P.O. Box 480 Bohemia, NY 11716 516-567-7300	Meteorological supplies
Cole-Parmer 7425 North Oak Park Ave. Chicago, IL 60648 312-647-7600	ASTM thermometers
Davis Instruments 513 E. 36th Street Baltimore, MD 21218 301-243-4301	Thermographs
Hydrolab Corp. P.O. Box 50116 Austin, TX 78763 512-255-8841	Thermographs
Ikelite Underwater Systems 50 West 33rd Street P.O. Box 88100 Indianapolis, IN 46208 317-923-4523	Waterproof thermograph housings
Jim-Gem Forestry Suppliers 205 West Rankin St. P.O. Box 8397 Jackson, MS 39204 601-354-3565	General forestry supplies
Met One, Inc. 481 California Ave. Grants Pass, OR 97526 503-479-1248	Meteorological supplies

Omnidata
P.O. Box 3489
Logan, UT 84321
801-753-7760

All Instrumentation

Pioneer & Company
216 Haddon Ave.
Westmont, NJ 08108
609-854-2424

Waterproof thermograph
housings

Ryan Instruments
P.O. Box 599
Redmond, WA 98073-0599
206-883-7926

Thermographs

Thomas Scientific
Vine Street at Third
P.O. Box 779
Philadelphia, PA 19105-0779
215-574-4500

ASTM thermometers

Weathertronics
Instrumentation
Box 41039
Sacramento, CA 95841

Meteorological
supplies

APPENDIX C. PROGRAM SNIPPETS

The following three programs have been included for their potential usefulness in data synthesis. The first is a FORTRAN program that can estimate hourly air or soil temperatures given minimum and maximum temperatures. The second is a BASIC program that can compute dew point and relative humidity from wet and dry bulb temperatures. The last is a Lotus 1-2-3 template useful for calculating the width versus flow relationship. All should be modified to suit your unique purposes.

```

C      SUBROUTINE TEMP(T, TMX, TMN, HR, A, B, C, NDAY, APhi)
C
C      THIS SUBROUTINE CALCULATES THE TEMPERATURE FOR A SPECIFIC HOUR C
C      GIVEN THE MAXIMUM AIR OR SOIL TEMPERATURE.
C      IT IS CORRECTED FROM:
C          PARTON, W.J. AND J.A. LOGAN. 1981.
C          A MODEL FOR DIURNAL VARIATION IN SOIL AND AIR TEMPERATURE
C          AGRICULTURAL METEOROLOGY 23(1981)-.205-216
C          WITH ERRATA FROM REPRINT PAGE 219
C
C      TMX = MAXIMUM TEMPERATURE
C      TMN = MINIMUM TEMPERATURE
C      T   = TEMPERATURE AT THE SPECIFIED HOUR
C      HR  = HOUR FOR WHICH THE TEMPERATURE IS CALCULATED (0-24)
C      A   = TIME LAG IN MAXIMUM TEMPERATURE AFTER NOON (HR)
C      B   = COEFFICIENT THAT CONTROLS TEMPERATURE DECREASE AT NIGHT
C      C   = TIME LAG FOR THE MINIMUM TEMPERATURE AFTER SUNRISE (HR)
C      NDAY= THE JULIAN DATE (1-365)
C      APhi= LATITUDE (RADIANS)
C      CALCULATE DAY LENGTH (ADY-HR) AND NIGHT LENGTH (ANI-HR)
C
C      ADELTA = .4014 * SIN(6.28 * (NDAY - 77.) / 365.)
C      TEM1 = 1. - (-TAN(APhi) * (ADELTA)) ** 2
C      TEM1 = SQRT(TEM1)
C      TEM2 = (-TAN(APhi) * TAN(ADELTA))
C      AHOU = ATAN2(TEM1, TEM2)
C      ADY  = (AHOU / 3.14) * 24.
C      ANI  = (24. - ADY)

```

(Continued)

(Concluded)

```
C DETERMINE IF THE HOUR IS DURING THE DAY OR NIGHT
  BB - 12. - ADY / 2. + C
  BE - 12. + ADY / 2.
  BT - HR
  IF (BT .GE. BB .AND. BT .LE. BE) GOTO 3
C CALCULATE TEMPERATURE FOR A NIGHT TIME HOUR
  IF (BT .GT. BE) BBD - BT - BE
  IF (BT .LT. BE) BBD - (24. - BE) + BT
  DDY - ADY - C
  TSN - (TMX - TMN) * SIN((3.14 * DDY) / (ADY + 2 * A)) + TMN
  T - TMN + (TSN - TMN) * EXP(-B * BBD / ANI)
  GOTO 4 C CALCULATE TEMPERATURE FOR A DAY
TIME HOUR
3 BBD - BT - BE
  T - (TMX - TMN) * SIN((3.14 * BBD) / (ADY + 2 * A)) + TMN
4 CONTINUE
  RETURN
  END
```

```

1 REM PROGRAM HUMID.BAS -- COMPUTES DEW POINT AND RELATIVE HUMIDITY
2 REM ADAPTED FROM Blackadar, A.K. 1983.
3 REM USING HOME COMPUTERS TO STUDY THE WEATHER
4 REM WEATHERWISE, AUGUST 1983, P195
10 PRINT "ENTER THE DRY-BULB TEMPERATURE"
20 INPUT T
30 PRINT "ENTER THE WET-BULB TEMPERATURE"
40 INPUT T1
50 PRINT "TYPE 'C' OR 'F' TO INDICATE CELSIUS OR FAHRENHEIT"
60 INPUT U$
70 PRINT "ENTER HEIGHT ABOVE SEA LEVEL IN FEET"
80 INPUT H
90 IF U$ - "C" OR U$ = "c" GOTO 120
100 T = (T - 32) * 5 / 9
110 T1 = (T1 - 32) * 5 / 9
120 T = T + 273.15
130 T1 = T1 + 273.15
140 E1 = EXP(21.4 - 5351 / T1)
150 P = 1014 - (H / 2900) * 100
160 E = E1 - P * (T - T1) / 1555
170 D = 5351 / (21.4 - LOG(E))
180 D = D - 273.15
190 IF U$ - "C" OR U$ = "c" GOTO 210
200 D = D * 9 / 5 + 32
210 E2 = EXP(21.4 - 5351 / T)
220 R = 100 * E / E2
230 Q = .622 * E / (P - .378 * E)
240 PRINT
250 PRINT "                                ANSWERS"
260 PRINT
270 IF U$ = "C" OR U$ = "c" GOTO 300
280 PRINT "DEW POINT = "; D; " F."
290 GOTO 310
300 PRINT "DEW POINT = "; D; " C."
310 PRINT "VAPOR PRESSURE = "; E; " MB."
320 PRINT "SATURATION VAPOR PRESSURE = "; E2; " MB."
330 PRINT "RELATIVE HUMIDITY = "; R; " PERCENT."
340 PRINT "SPECIFIC HUMIDITY = "; 1000 * Q; " PARTS PER THOUSAND."
350 END

```

A	B	C	D	E	F	G	H	I	J
1	LOTUS 1-2-3 WIDTH VS FLOW RELATIONSHIP								
2	POUDRE RIVER FROM PAT NELSON'S PHABSIM DATA								
3									
4	Martinez Park								
5			Y	X				Predicted	
6	Q (cfs)	Width(f	@LN(Width	8LN(Q)				Width	
7	W	t))						
8	2	27.96	3.33	0.69	Regression Output:			23.75821	
9	5	26.54	3.28	1.61	Constant		3.0220	28.81073	
10	10	30.29	3.41	2.30	Std Err of Y Est		0.0854	33.33509	
11	50	43.68	3.78	3.91	R Squared		0.9665	46.77238	
12	100	52.83	3.97	4.61	No. of Observations		9	54.11738	
13	200	65.33	4.18	5.30	Degrees of Freedom		7	62.61582	
14	300	69.10	4.24	5.70				68.19302	
15	400	73.92	4.30	5.99	X Coefficient(s)		0.210435	72.44884	
16	500	78.39	4.36	6.21	Std Err of Coef.		0.014803	75.93198	
17	=====								
18					@AVG(Predicted Width) =			51.77594	
19	[to be used in shade file]								
20									
21					A-term = 9EXP(Constant)		20.533	(dimension less)	
22					=		66		
23					B-term = X Coefficient		0.2104	(dimension less)	
					=		35		
					Thus, Predicted Width =		20.53	* Q ^ *	0.21
					Thus, Predicted Width = @ EXP (\$H\$9)		* Q ^	\$G\$15	

APPENDIX D. ALTERNATIVE DATA FORMATS FROM THE HYDRODATA DATA BASE

Table D-1. Textual output file from Hydrodata (tm U.S. West Corporation) for mean daily water temperature (°C). Similar tables are often available for daily maximum, daily minimum, and/or random interval water temperature. There may also be data on humidity (%), solar radiation (c/cm²), air temperature (°C or °F), soil temperature (°C), wind speed (mph), as well as a variety of water quality data. "Remarks" data files may also be available.

08037000 ANGELINA RIVER NR LUFKIN, TEX (DISC)

LOCATION. -- Lat 31:27:26. Long 094:43:34, Hydrologic Unit 12020005.

DRAINAGE AREA. -- 1600.00 mi² (4144.00 km²).

GAGE. -- Altitude of gage is 0164.72 ft (50 m).

1957

TEMPERATURE, WATER (DEG.C), WATER YEAR OCT 1956 TO SEP 1957

STATISTIC CODE 30830

DAY	Oct	Nov	Dec	Jan	Feb	Mar	Apr	May	Jim	Jul	Aug	Sep
1	22	15	7.2	10	11	13	16	19	24	27	29	28
2	22	16	7.2	9.4	11	13	18	22	24	27	29	28
3	22	15	8.3	8.9	12	13	21	22	23	28	29	28
4	23	16	11	12	11	14	18	22	22	28	29	27
5	23	17	14	11	15	15	18	20	23	28	29	27
6	23	17	15	11	16	13	16	19	23	29	28	27
7	23	18	17	11	15	11	18	19	24	28	27	26
8	19	16	16	11	16	9.4	18	21	26	28	27	24
9	19	12	12	15	11	10	16	21	26	32	28	24
10	18	13	11	13	17	13	16	--	27	29	27	24
11	18	12	11	--	17	14	18	23	27	29	27	23
12	19	13	12	11	17	14	19	24	28	29	28	24
13	19	13	13	12	15	14	13	24	27	30	28	24
14	19	17	12	13	14	16	15	24	27	30	28	24
15	20	18	14	10	17	14	16	24	27	29	28	26
16	20	13	11	8.9	16	14	17	24	27	29	29	24
17	19	12	12	6.7	14	16	--	25	27	29	29	24
18	19	12	14	5	14	17	20	--	27	30	--	25
19	19	12	13	5	13	15	20	23	27	29	28	25
20	21	16	13	7.8	12	16	21	24	26	29	27	26
21	20	14	12	11	11	16	21		22	29	27	27
22	18	11	13	13	11	15	21	26	26	28	27	25
23	20	11	12	8.3	13	18	23	26	26	28	28	23
24	18	10	11	8.9	11	15	21	25	24	27	27	26
25	18	10	9.4	8.9	14	13	21	26	24	26	27	21

(Continued)

Table D-1. (Concluded)

DAY	Oct	Nov	Dec	Jan	Feb	Mar	Apr	May	Jun	Jul	Aug	Sep
26	18	13	--	8.9	13	14	22	25	26	27	28	22
27	16	8.3	--	--	12	13	22	24	24	27	28	22
28	16	7.2	8.9	9.4	12	13	21	24	24	28	28	21
29	16	7.2	8.9	12	--	13	20	24	26	28	28	21
30	19	7.2	7.8	10	--	15	20	24	27	28	28	21
31	--	--	8.3	10	--	16	--	24	--	28	28	--
Tota	585	392	336	292	380	437	544	650	762	882	839	737
Mean	19	13	12	10	14	14	19	23	25	28	28	25
Max	23	18	17	15	17	18	23	26	28	32	29	28
Min	16	7.2	7.2	5	11	9.4	13	19	22	26	27	21
WTR YR 1957	TOTAL		6835	MEAN	19	MAX	32	MIN	5.0			

Table D-2. Textual output file from Climatedata (tm U.S. West Corporation) for maximum daily air temperature (°C or °F). Minimum daily air temperature is usually also available.

Station	GORE PASS RANCH										Parameter	TMax	
County	JEFFERSON										Record Cnt	7	
State	CO										Coverage %	83	
Id	3423										Elevation	7600.00	
Latitude	40:09:00										Observed Time	16000 hrs	
Longitude	106:28:00										MissingD/M	9 / 0	
											Begin Date	6 /1957	
											End Date	12 /1963	
Daily Maximum Temperature, in degrees Centigrade													
1963	Jan	Feb	Mar	Apr	May	Jun	Jul	Aug	Sep	Oct	Nov	Dec	Annual
1	-8	9	2	15	17	24	29	29	20	24	8	7	
2	-7	6	3	10	17	19	29	24	22	24	12	3	
3	-2	9	-2	5	20	20	27	22	24	23	12	2	
4	0	12	0	12	22	24	26	20	--	24	8	3	
5	-5	8	-2	12	22	19	27	22	--	23	8	5	
6	-7	8	1	16	23	23	30	23	--	21	13	3	
7	--	6	0	18	24	24	30	26	--	21	13	--	
8	--	11	3	14	23	23	29	24	21	23	10	--	
9	-2	6	6	14	19	16	22	--	24	21	11	3	
10	1	0	5	11	22	21	21	--	--	23	14	-1	
11	-13	-5	3	12	22	23	23	24	--	22	--	-6	
12	-21	-4	1	17	17	25	21	23	--	21	--	-7	
13	-23	-1	0	19	19	28	26	26	26	17	11	-5	
14	-13	1	5	20	20	28	27	27	19	18	16	-1	
15	-4	2	6	16	21	23	26	28	23	19	14	-1	
16	-2	1	0	9	19	16	29	23	23	21	11	-4	
17	-2	4	6	14	21	19	29	17	23	21	-1	-4	
18	-14	3	4	10	21	16	31	25	26	21	0	1	
19	-6	7	4	5	17	22	31	27	25	18	2	--	
20	--	7	6	10	20	25	32	23	23	15	3	--	
21	6	5	9	14	--	25	29	19	21	16	9	--	
22	0	4	11	11	22	26	24	23	23	18	2	--	
23	1	6	14	10	18	27	30	19	24	16	3	--	
24	4	9	12	11	18	26	31	26	22	12	2	4	
25	-1	4	9	16	18	26	31	26	24	18	5	6	
26	-6	8	13	18	19	27	27	24	27	19	4	1	
27	-6	1	16	17	--	--	27	25	--	18	--	0	
28	1	2	13	10	--	29	29	21	--	18	--	--	
29	0	--	11	14	21	27	29	24	--	18	--	-1	
30	5	--	16	17	24	28	31	24	--	17	4	-3	
31	7	--	17	--	17	--	--	21	--	12	--	--	
Mean	-4	5	6	13	20	23	28	24	--	19	8	0	--
Max	7	12	17	20	24	29	32	29	--	24	16	7	--

Table D-3. Part of a Lotus 1-2-3 (tm) worksheet created by Hydrodata Optical Disk Database.

ABBREVIATED EXAMPLE OF HYDRODATA DATABASE PRINTOUT

31	31	31	31	31	31
USGS	USGS	USGS	USGS	USGS	USGS
06768000	06768000	06768000	06768000	06768000	06768000
31	31	31	31	31	31
047	047	047	047	047	047
PLATTE R PLATTE R PLATTE R PLATTE R PLATTE R PLATTE R PLATTE RIVER NEAR OVERTON					
SW	SW	SW	SW	SW	SW
404057	404057	404057	404057	404057	404057
0993224	0993224	0993224	0993224	0993224	0993224
00	00	00	00	00	00
999999	999999	999999	999999	999999	999999
999999	999999	999999	999999	999999	999999
999999	999999	999999	999999	999999	999999
57700	57700	57700	57700	57700	57700
52900	52900	52900	52900	52900	52900
-99999	-99999	-99999	-99999	-99999	-99999
2298.830	2298.830	2298.830	2298.830	2298.830	2298.830
1978	1979	1980	1981	1982	1983
1	1	1	1	1	1
1	1	1	1	1	1
10	10	10	10	10	10
10	10	10	10	10	10
10200101	10200101	10200101	10200101	10200101	10200101
34.50	25.00	30.00	31.50	21.10	
31.50	26.50	30.50	31.50	20.50	
30.50	26.00	30.00	33.50	23.30	
32.00	25.00	31.00	34.50	26.10	
33.00	24.00	29.00	30.50	26.70	
31.50	20.50	31.50	27.00	24.40	
34.00	20.00	29.50	30.00	23.30	
35.50	19.50	23.00	26.00	26.70	
33.50	20.50	31.00	25.00	28.90	
33.00	20.00	33.00	28.50	27.80	
33.50	20.00	32.00	30.50	26.70	
28.00	19.00	33.00	30.50	24.40	
33.00	19.50	32.00	30.00	25.50	
34.00	20.00	31.00	28.50	26.70	
28.00	20.00	30.50	30.50	27.80	
29.00	20.50	29.50	31.50	25.50	
28.50	21.00	34.50	33.50	26.70	
35.50	21.00	31.00	34.00	27.20	
31.50	23.50	33.50	33.50	27.80	
32.00	24.50	34.50	32.00	27.20	
34.50	23.00	33.50	34.50	27.80	
31.00	22.00	33.00	34.00	28.90	
35.00	22.00	33.00	30.50	26.70	
29.50	22.00	33.00	30.00	27.80	
29.50	22.00	31.00	31.50	30.00	
31.50	22.00	33.50	32.00	30.50	
27.00	22.00	32.00	29.00	30.50	
24.00	23.50	33.00	29.00	29.40	
26.00	23.50	33.50	32.00	29.40	
28.00	24.50	31.50	26.00	30.50	
29.50	23.50	30.50	30.00	31.70	

Table D-4. Textual output file from Hydrodata (tm U.S. West Corporation) for streamflow (cfs). There may be many variations on streamflow statistics, such as reservoir storage (af, mg, kaf, mcf, or cfs-d) or level (ft), and river stage (ft).

08066100 WHITE ROCK CREEK NR TRINITY, TEX.

LOCATION -- Lat 31:03:06, Long 095:22:40, Hydrologic Unit 12030202

DRAINAGE AREA -- 222.00 mi2 (574.98 km2)

GAGE -- Altitude of gage is 0124.30 ft (38 m)

STREAMFLOW (CFS), WATER YEAR OCT 1984 TO SEP 1985

MEAN

DAY	Oct	Nov	Dec	Jan	Feb	Mar	Apr	May	Jun	Jul	Aug	Sep
1	0	131	33	900	38	894	43	38	9.7	.41	1.1	0
2	0	146	26	928	33	1640	36	29	7.9	.38	.69	0
3	0	194	21	399	30	494	29	27	6.9	.35	.48	0
4	0	115	18	474	31	155	25	18	6.0	.33	.34	0
5	0	76	19	212	37	98	22	15	5.4	.31	.23	0
6	0	60	201	91	56	65	19	12	4.8	.27	.17	0
7	0	51	152	58	51	49	18	11	4.2	3.7	.10	0
8	6.9	45	48	43	38	41	17	9.8	3.7	6.7	.08	0
9	3.0	38	32	35	31	37	15	9.1	3.2	6.8	.06	0
10	1.1	41	26	43	248	32	14	8.7	4.0	6.8	.05	0
11	.36	39	23	206	1660	30	14	9.5	4.5	5.3	.04	0
12	.84	35	21	83	2400	28	14	8.4	3.5	5.3	.02	0
13	5.2	33	203	44	534	26	14	321	2.8	3.4	.010	0
14	10	33	1020	35	127	26	13	3250	2.4	4.8	0	0
15	5.3	32	1280	33	83	27	13	2350	2.2	4.2	0	0
16	2.3	37	650	406	61	31	12	416	2.0	2.4	0	0
17	2.0	30	900	1590	49	29	12	88	1.8	3.9	0	0
18	0.81	63	356	2160	42	25	11	50	1.6	6.3	0	0
19	55	78	112	572	36	22	10	33	1.4	10	0	0
20	934	70	69	141	32	412	9.9	27	1.3	23	0	0
21	2720	47	50	81	31	1290	9.9	53	1.1	302	0	0
22	2680	35	39	57	30	1030	9.9	79	1.0	97	0	0
23	1390	30	32	48	326	164	11	54	.90	25	0	0
24	1250	28	27	46	1240	83	398	32	.80	15	0	0
25	2330	30	24	43	1260	57	2130	24	.72	10	0	0
26	1380	36	19	38	193	45	588	20	.65	7.7	0	0
27	388	312	21	36	157	42	202	18	.58	5.8	0	0
28	647	513	21	51	244	53	151	17	.53	4.6	0	0
29	4100	110	21	88	—	65	66	15	.49	3.5	0	0
30	2100	47	21	57	—	44	49	12	.45	2.7	0	0
31	319	—	186	43	—	39	—	11	—	1.8	0	0
Total	20331	2535	5671	9041	9098	7073	3976	7066	87	570	3.4	0
Mean	656	84	183	292	325	228	133	228	2.9	18	.11	0
Max	4100	513	1280	2160	2400	1640	2130	3250	9.7	302	1.1	0
Min	0	28	18	33	30	22	9.9	8.4	.45	.27	0	0
Ac-Ft	40326	5028	11248	17933	18046	14029	7886	14014	172	1130	6.7	0
WTR YR 1985	TOTAL	65450	MEAN	179	MAX	4100	MIN	0	AC-FT	129817		

APPENDIX E. SELECTED METEOROLOGICAL DATA FOR JULY

The following figures are taken from U.S. Department of Commerce (1968)

Figure E-1. Normal daily average temperature for July.



Figure E-2. Mean relative humidity for July.

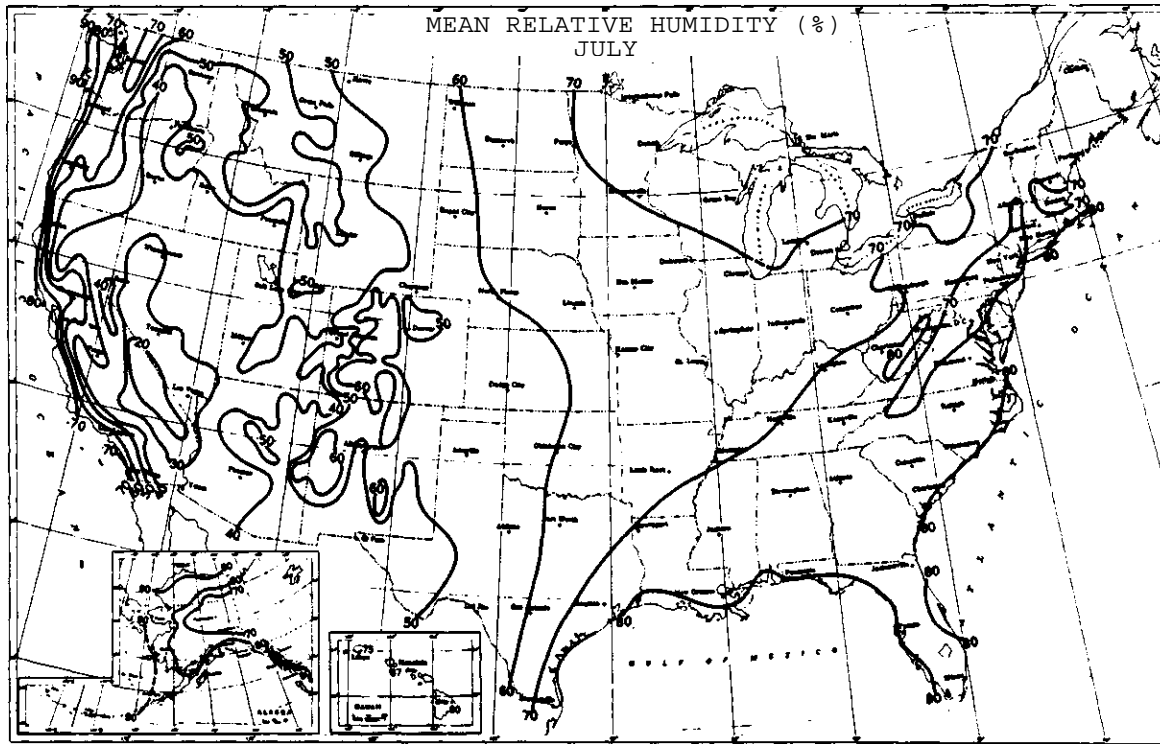

Figure E-3. Mean percentage of possible sun for July.

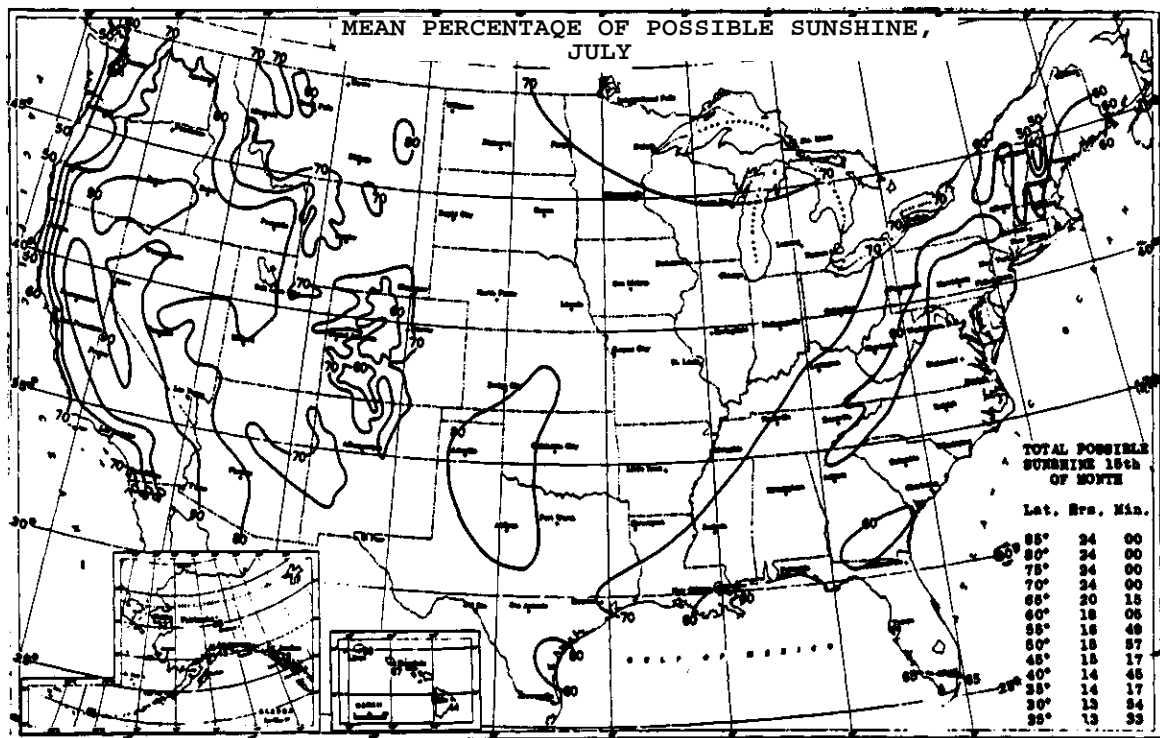

Figure E-4. Mean daily solar radiation for July.

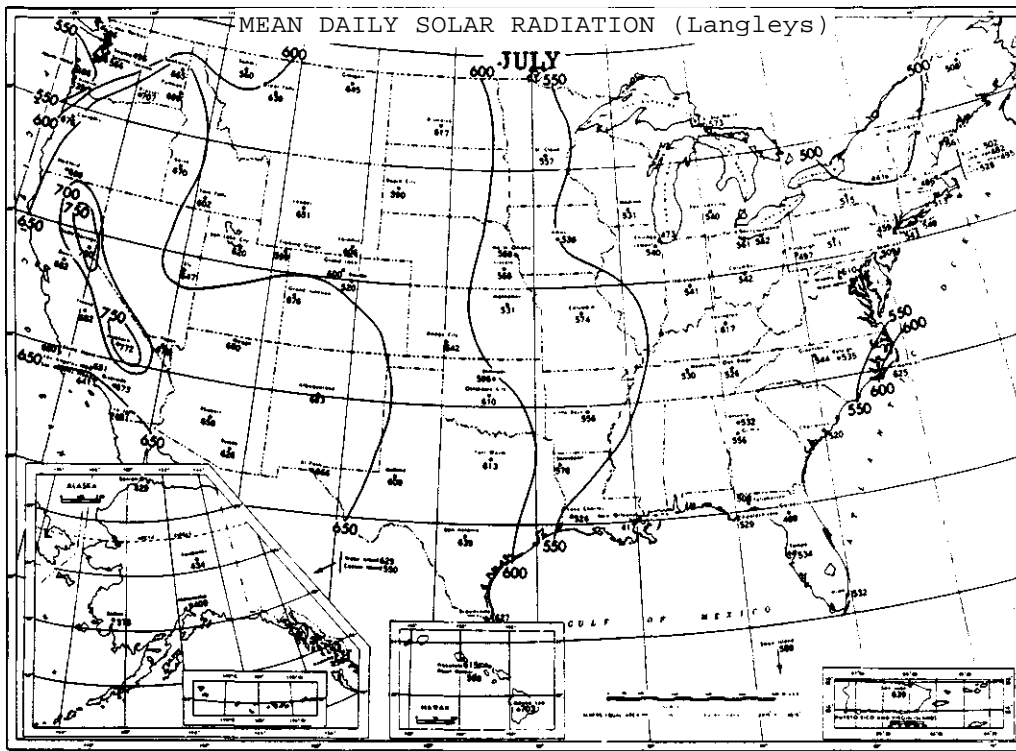
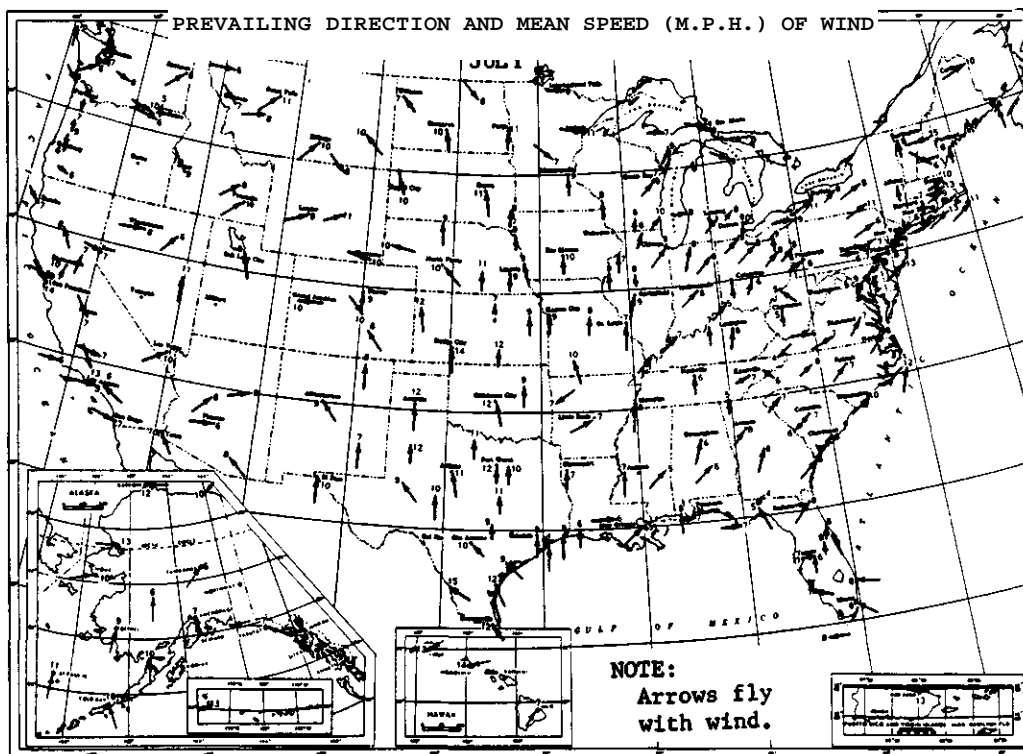

Figure E-5. Mean wind speed for July.



INDEX

- accretion rate, 73
accuracy of models, 6, 26, 27, 34, 48, 62, 63, 72, 90, 114
acute temperatures, 23
ADDBEND program, 14
adiabatic lapse rate, 36
advective heat flux, 70
air, vi, vii, viii, 1, 8, 10, 12, 13, 20, 21, 24, 35-37, 39-43, 46, 48, 50, 55, 65, 67, 69, 70, 73, 74, 76, 85-87, 99, 101, 103-105, 110, 112, 114, 115, 123, 127, 129
anemometer, 46
AVDEPTH, 14
azimuth of stream, 27, 29
- bank, stream, vi, 27, 29, 30, 46, 71
baseline conditions, 5
BASIC programs, 42, 87, 89, 92, 123
battery power, 39, 62, 63
bends, stream, 14, 83
bias in models, 13, 40, 62, 71, 93-95, 108
biweekly time step, 46
bottom of stream, 14, 18, 20, 21, 79, 81, 95, 102
braided channel, 14
- calibration of models, iii, v, vii, 5, 39, 41, 44, 46, 50, 62, 65, 67-69, 71, 72, 89, 90, 91-93, 96, 100, 103, 107
clearcutting trees, vi, 22-25, 32, 107, 109, 110, 114
cliffs, 21
climate, 1, 35, 41, 45, 49, 74, 105, 109, 111, 114, 116, 118-120
CLIMATEDATA, viii, 40, 120, 129
- clinometer, vi, 26, 27, 30
clouds, 23, 24, 27, 35, 44-46, 50, 65, 93, 95, 97, 118
conduction, 20, 21, 96, 112
convection, 12, 39, 46, 96
correlation, 7, 26, 36, 37, 53, 71, 75-77, 88, 90, 98, 100, 105, 114
curvilinear relations, 16
- daily time step, vi, vii, viii, 6, 10-12, 14, 21, 24, 35, 36, 40, 41, 43, 53, 55, 56, 57, 59, 65, 72, 74, 85-87, 90, 94-96, 99, 101, 102, 104, 105, 111, 116-118, 127, 129, 132, 134
dams, 1, 7, 41, 55, 56, 67, 75, 98, 111, 113, 116
day length, viii, 7, 26, 51, 52, 123
daylight, 26, 40
debris in stream, 23, 62, 67
deciduous vegetation, 23, 26, 30, 32
declination, 52
densitometer, 32, 113
density of vegetation, vi, 26, 30, 32, 33, 67, 77, 113
depth, viii, 10, 12, 13, 18, 20, 21, 48, 56, 61, 75, 76, 77, 79-81, 83, 89, 97, 108
dew, 35, 36, 43, 114, 123, 125
diel, vi, 21, 22
digital, 39, 44, 62, 63, 71
discharge, iii, vi, 1, 14, 16-19, 23, 24, 26, 48, 53, 54, 67, 69, 70, 74, 76, 79, 86, 99, 102, 105
distances, 12, 13, 65
diurnal temperatures, 1, 20, 21, 25, 46, 70, 72, 79, 96, 115, 123
duration analysis, vii, 37, 81, 104, 105
dust coefficient, 44, 45, 50
dye, vi, 18, 19, 112

elevation, 7, 12, 13, 26, 35-37,
 41, 42, 75, 76, 81, 114, 129
 empirical, 14, 16, 41, 76, 86, 96,
 97, 99-102, 116
 epilimnionic temperatures, 98
 error, model, iii, vii, 6, 7, 13,
 16, 18, 20, 21, 24, 43, 45, 46,
 65, 68, 70-72, 75, 86-88, 92-99
 estimates, parameter, 16, 18, 24,
 26, 32, 41, 43, 45, 46, 50, 71,
 73, 74, 78, 83, 86, 87, 92, 101,
 113, 115, 119
 evaporation rate, 39, 69, 96
 extreme cases, 23, 36, 54, 59, 79,
 84, 90, 93, 100, 101, 103, 105

 failure of equipment, 23, 39, 48,
 62, 63
 filters, 100
 flood, 1, 76
 flow, iii, vi, vii, 1, 5, 6, 7, 8,
 9, 10, 12-16, 18, 19, 21, 26,
 27, 29, 36, 51, 53, 54, 65, 67-
 71, 73-87, 96-103, 105, 108,
 109, 111, 112, 114, 116-119,
 123, 126
 fluorescein dye, 18
 fluorometer, 18
 flushing, 98
 flux, heat, 12, 13, 20, 21, 39, 46,
 74, 97, 99
 forebay, 67
 forecast, 35, 105

 gage, 18, 53, 55, 67, 127, 131
 geological, 53, 55, 57, 112-115, 120
 geometry, stream, iii, v, 6, 12, 73,
 85, 88, 100-103
 geothermal areas, 48, 84, 113
 goodness-of-fit, iii, 90, 92, 93,
 116
 gradient, stream, 8, 10, 12, 13, 19-
 21, 48, 84
 ground, vi, viii, 10, 13, 20, 21, 24,
 36, 41, 48-51, 70, 71, 76, 79,
 84, 92, 111
 ground reflectivity, 48, 50

 ground temperature, vi, 8, 10, 20,
 21, 48
 groundwater, 12, 23, 24, 48, 50,
 51, 53-55, 70, 71, 73, 80, 92

 habitat, stream, iii, 6, 13, 18,
 54, 79, 81, 92, 108-111, 114,
 115, 117, 118
 HABTAT program, 14
 HAQF data file, 14
 harmonic models, 75, 76, 87,
 99, 100, 117
 headwater, 7, 36, 65, 80, 114
 HEC program, 78
 height of vegetation, vi, 27, 30,
 41, 43, 46, 47, 125
 historical conditions, 53, 55, 85,
 90, 97
 hourly time step, vi, 21, 25, 35,
 39, 41, 63, 96, 98, 109, 118,
 123
 humidity, vi, vii, 8, 10, 13, 36,
 41-44, 55, 86, 103, 105, 114,
 123, 125, 127, 133
 hydraulic, 16, 18, 101,
 102
 HYDRODATA data base, v,
 viii, 53, 55, 120,
 127, 130, 131
 hydrology, iii, v, 12,
 51, 77, 78, 88, 92,
 100, 102, 111, 113,
 115, 120, 127, 131
 hydropeaking, 98

 ice, iii, 21, 51, 68, 74, 76,
 110, 114
 impoundment, 18, 75, 76, 109,
 113, 117
 inflow, 7, 8, 10, 12, 48, 53, 54,
 75, 77, 80, 92
 instrumentation, iv, 39, 62, 96,
 107, 122
 intergravel flow, 80
 irrigation, 53, 55, 70, 71

 Julian days, 87, 99, 123

Lagrangian methods, 99, 112
 lapse rate, vi, 36, 37
 LARM model, 78, 111
 latent heat, 74
 lateral flow, 7, 18, 48, 55, 71, 79, 86
 latitudes, viii, 24, 26, 27, 44, 45, 52, 57, 123, 129
 leaf, 51
 lethal temperatures, 23
 level plane, 26, 36, 39, 41-43, 46, 50, 67, 70, 77, 78, 81, 89, 103, 125, 131
 light, 18, 21, 26, 30, 34, 51, 98, 108, 112, 116, 119
 local conditions, viii, 6, 26, 35, 36, 43, 48, 63, 101, 114
 log, 14, 71, 86, 125
 logarithmic, 34, 119
 logs in stream, 21, 22, 97
 longitude, 57, 79, 81, 94, 129
 losing stream, 53, 54
 Lotus 1-2-3, viii, 14, 123, 126, 130

 Manning's n, 14, 16, 19, 81, 83, 101, 102
 map, 13, 18, 27, 114
 maximum temperature, vi, viii, 6-8, 10-12, 14, 21, 23-25, 30, 36, 40, 41, 43, 56, 57, 59, 61, 65, 68, 70-72, 74-76, 81, 85, 86, 90, 93, 97, 99, 101-105, 123, 127, 129
 mean temperature, vi, vii, viii, 2, 5-8, 10-12, 18, 20, 24, 33, 35, 39-41, 43, 48, 50, 53, 56, 57, 59, 61, 65, 67, 69, 70, 73, 75, 86, 87, 92, 93, 95, 96, 99, 101-104, 106, 110, 112, 118, 127-129, 131, 133, 134
 median conditions, 10, 36
 meteorology, iii, v, vi, 12, 34, 35, 37-40, 43, 46, 48, 73, 74, 85, 87, 88, 97, 99-103, 105, 112, 113, 118, 120-123, 132
 microclimate, 41
 microhabitat, vii, 6, 74, 80, 84, 89
 microthermal habitats, 54, 79, 84
 minimum temperature, 6, 10, 18, 21, 23, 25, 36, 39-41, 56, 57, 59, 61, 65, 70-72, 75, 81, 86, 88, 95, 104, 105, 123, 127, 129
 missing values, 46, 56, 86-88, 99, 100, 102
 mixing equation, 55, 67, 69, 79, 81, 83, 84, 101
 monitor, vii, 7, 66, 67, 85, 107
 Monte Carlo method, 100, 103, 105
 month, 2, 6, 35, 36, 39, 40, 41, 46, 53, 58, 59, 61, 63, 76, 94, 95, 98, 99, 105, 108, 112, 118, 119

 NAWDEX data base, 53, 120
 normal conditions, vii, 24, 35, 36, 75, 90, 95, 101, 103, 105, 118, 132

 optimization methods, 78
 oxygen, 77, 96-98, 107, 108

 parameter, iii, vi, viii, 6-8, 10-12, 13, 20, 23, 26, 27, 31, 35, 37, 39, 41, 43, 46, 48, 50, 76, 85, 86-90, 92, 94, 97, 102, 103, 105, 129
 percent possible sun, 8, 10, 36, 44-46, 86, 103
 permanganate, 18
 PHABSIM method, 13, 14, 18, 53, 114, 126
 planimetry, 44
 pool, vii, 14, 16, 79-82, 83, 84, 107, 115
 priority, iii, vii, 6, 65, 66
 probability, 65, 101, 102, 103, 105, 116, 119
 profile, temperature, vii, 16, 25, 48, 65, 67, 77, 82, 102, 112, 115
 psychrometer, 42
 psychrometer, 41
 pyranograph, 43, 44
 pyranometer, 43
 pyrgeometer, 43
 pyrheliometer, 34, 43
 pyrradiometer, 43

radiation, vi, vii, viii, 10, 12, 20, 21, 24, 27, 28, 32, 34, 35, 39, 43, 44-46, 48, 50, 55, 86, 88, 94, 96-98, 103, 105, 113, 114, 116, 118, 127, 134
 random, 14, 27, 87, 94, 127
 reconnaissance, 70
 reflectivity, viii, 48, 50, 51
 regression techniques, iii, 14, 16, 24, 39, 65, 85-88, 90, 93-96, 99, 101-103, 126,
 reservoir, iii, 1, 5, 7, 36, 43, 53, 54, 65, 67, 71, 74-78, 85-87, 92, 95, 98, 100, 101, 102, 103, 107, 109, 111, 115, 119, 131
 residuals, error, 93, 111
 resolution, 63, 71, 97, 104
 retrieval, data, 56, 61
 rhodamine dye, 18
 riparian vegetation, vi, 7, 13, 21, 23, 24, 26-28, 31, 46, 92, 96, 97, 108, 113, 115, 118
 RMS error, 20, 98
 roughness, streambed, 8, 10, 14, 16, 46, 48, 81, 83, 98
 routing, 18, 98, 112
 Ruthven equation, 81, 116

 samples, 27, 32, 59, 62, 63, 86, 87, 89, 93, 100, 101, 108, 111
 saturation, 20, 33, 125
 scoping, 5
 screening, 21, 30, 32
 seeps and springs, 79
 segment, stream, 7, 10, 13, 14, 18, 26, 27, 32, 65, 88, 89, 98, 107, 108
 SELECT model, 32, 53, 69, 74, 78
 sensitivity analysis, iii, v, vi, viii, 6-8, 10-12, 13, 20, 21, 26, 39, 41, 54, 65, 84, 85, 88, 89, 90, 103, 110, 116
 shade, riparian, vi, 7, 8, 10, 21-27, 30-34, 40, 69, 70, 75, 85, 88, 96-98, 100, 103, 107, 114, 115, 117, 126
 shadow, 26, 34, 43, 44, 69
 Sine wave, 40, 75, 77, 87
 sinuosity, stream, 13
 site selection, 65

 SNTEMP model, iii, vi, viii, 1, 5, 7, 10, 11, 13, 14, 16, 19, 20, 26, 43, 45, 50, 51, 53, 54, 71, 74, 78, 86, 88, 93, 95, 97, 101, 102
 soil, 46, 48, 51, 71, 109, 113, 115, 117, 123, 127
 solar, vi, vii, viii, 10, 12, 20, 21, 24, 28, 28, 32, 43-46, 48, 50, 55, 86, 88, 94, 97, 98, 101, 103, 105, 107-109, 114, 116, 118, 127, 134
 solar radiation, vi, vii, viii, 10, 12, 20, 21, 24, 28, 32, 35, 43-46, 48, 50, 55, 86, 88, 94, 97, 98, 103, 105, 114, 116, 127, 134
 solarimeter, 34
 springs and seeps, 36, 48, 54, 56, 70, 75, 76, 80, 84, 105
 SSSHADE program, 24, 26, 88, 107
 SSSOLAR program, 24, 43, 44, 50, 88, 107, 108
 SSTEMP program, 88, 95, 101, 108
 staff gage, ix, 18, 53
 statistical methods, 37, 88-90, 92, 93, 95, 99, 100, 102, 108, 112, 116
 STEADY model, iii, 16, 78, 96-99
 stochastic models, 96, 116, 117
 STORET data base, viii, 55, 61
 stratification, temperature, 65, 67, 70, 76, 77, 80-82, 84, 119
 streambed, 14, 16, 19-22, 67, 79, 97
 substrate, 12, 24, 97
 summer, 12, 51, 69, 74-76, 96, 100
 sun, vii, 8, 10, 21, 23, 26, 27, 32-34, 36, 43-46, 52, 86, 103, 133
 sunlight, 32-34, 45, 67
 sunshine, 34, 35, 45, 118

 theft, equipment, 63
 thermal gradient, 8, 10, 19-21
 thermistor, 62, 84
 thermocline, 80, 81
 thermograph, vii, viii, 39, 62, 63, 64, 70, 121, 122
 thermometer, 39, 41, 68-70, 84, 107, 115, 121, 122

time, vi, vii, viii, 6, 8, 10, 12,
 13, 16-19, 22, 26, 30, 34, 35,
 39-41, 43-46, 48, 50, 52, 53,
 55, 56, 62, 63, 65, 67, 70-74,
 76-79, 84, 86-90, 92, 93, 95,
 97-102, 105, 106, 108, 112,
 114, 123, 124, 129
 topography, vi, 13, 21, 24-28, 30,
 34, 35, 43, 46, 48, 50, 97
 toxic, 18, 105
 transect, vii, 18, 32, 53, 68
 transport, 13, 86, 98, 99, 110, 112
 travel time, vi, 8, 10, 13, 16-19,
 98, 101, 102, 108, 112
 tributary, 53, 55, 67, 73, 79-81,
 84, 86

 undergravel flow, 79, 84
 units of measure, vi, 10, 14-16,
 39, 44, 62, 63, 68, 71, 86
 USGS, viii, 27, 54-57, 59, 107,
 109, 110, 112, 117, 130

 validation of models, iii, v, vii,
 5, 62, 89-93, 95, 102, 110,
 114, 116, 117
 vandalism of equipment, 62, 63
 variance of results, 7, 39, 86, 93,
 95, 100
 vegetation, vi, 13, 21, 23, 24,
 26- 28, 30-32, 34, 37, 43, 46,
 51, 92, 97, 108, 115, 118
 verification of models, iii, 37,
 41, 43, 48, 62, 67, 73, 84, 89,
 90, 92, 107

 WASP model, 77
 wavelength, 20
 weekly time step, 6, 23, 35, 63,
 90, 94, 118
 WESTEX model, 78
 width, vi, 7, 8, 10, 13-15, 21,
 23, 26, 30, 32, 33, 76, 80,
 81, 83, 86, 92, 101, 103, 123,
 126

 wind, vi, vii, 8, 10, 12, 34-36,
 43, 46-48, 55, 75, 76, 86, 97,
 103, 127, 134
 winter conditions, 23-25, 36, 39,
 43, 59, 74-76, 84, 88, 100
 WQRRS program, 77, 78
 WSP program, 16, 102

 year, vi, vii, 1, 23, 25, 26, 30,
 35, 36, 41, 43-45, 48, 50, 55-
 60, 63, 65, 70, 74, 75, 76, 90,
 94, 98, 99, 103-106, 113, 118,
 127, 131